

# THE CLAY PAVER BOOK

ROOF / BRICK / PAVER / FACADE / BLOCK



  
**Wienerberger**

## WIENERBERGER

**Wienerberger is the UK's leading provider of wall, roof and landscaping innovations. We offer one of the broadest product portfolios in the construction business, including clay facing bricks (stock and wirecut), specialist engineering bricks, the Porotherm clay block system, facade solutions including SVK fibre cement panels, the Corium cladding system and a wide range of brick slips. We also offer a full range of Sandtoft and Koramic clay and concrete roofing products, Keymer handmade roof tiles, bespoke heritage products and a range of domestic and commercial pavers.**

Founded in 1819 and with headquarters in Vienna, Wienerberger Building Solutions is the world's largest producer of bricks and clay blocks, as well as being the market leader for clay roof tiles. We are represented in 27 countries with 217 production sites and 19,000 employees.

Find out more about our products and services at [www.wienerberger.co.uk](http://www.wienerberger.co.uk)

# CONTENTS

<b>Introduction to Wienerberger</b>	<b>2</b>
Our Values	4-5
We Are Future-Builders	6-7
Why Clay?	8-9
Bring the Outside In	10-11
Blends	12-13
Tumbled Pavers	14-15
Waterstruck Pavers	16-17
<b>Product Portfolio</b>	<b>18-19</b>
Dutch Pavers	20-25
Alder UWF Pavers	26-27
62 mm Range	28-29
Baggeridge Pavers	30-31
Diamond Pattern Pavers	32-33
KK80 Pavers	34-35
Sycamore Pavers	36-37
<b>Sustainable Urban Drainage</b>	<b>37-38</b>
Aquata Pavers	39-40
<b>Accessories</b>	<b>42-43</b>
Marker Pavers	44
Deterrent Pavers	45
Infill, Channel and Step Pavers	46-47
Kerbs	48-50
Tactile, Warning and Guidance Pavers	51
<b>Laying Patterns</b>	<b>52</b>
<b>Installation and Design Guidance</b>	<b>53</b>
<b>Index</b>	<b>54-55</b>

© Wienerberger Ltd 10/23. All rights reserved. N.B. Due to the limitations of the printing process and screen calibration settings when viewing the online version, you are advised to obtain product samples prior to purchase. All information contained in this book is believed to be correct at the time of going to press. Wienerberger reserve the right to add, delete or alter products without notice and recommend you contact us to obtain the latest information.

de bibliotheken

# OUR VALUES



## Sustainability and innovation

Let's Build Beyond with our sustainability strategy

For our business to be sustainable, we need to create enduring value - for us and for those around us. As well as providing product and service solutions for the challenges of climate change, biodiversity loss and resource scarcity in the built environment, Wienerberger Limited must become a net-zero emission, nature positive business.

We want to positively impact the communities in which we live, work, source and sell, and conserve the natural resources upon which we all depend.

From ideas to completion and beyond, we commit to supporting architects, designers, developers and merchants to create smarter, better-performing buildings and spaces that reduce our impact on the plane.

## Trusted expertise

Multi-specialists with heritage and experience

Wienerberger has supplied the construction industry with quality building products for over 200 years. Now, with solutions for the whole building envelope, our multi specialist teamwork with architects, housebuilders, merchants and housing authorities to take ideas to completion and beyond. Innovative products and systems that perform and last. Services to design and deliver projects successfully and to a high standard. Sustainable solutions that make new builds and renovations perform better. All delivered via a great service and a reliable set of hands. We are creating the experts of the future with our training, apprenticeship and CPD programmes; constantly building on our experience to improve that of our customers.

## Proven problem solvers

Finding the right solution for each challenge

We help customers succeed by finding unique solutions to their challenges. No two requirements are the same in terms of product, service, time or cost, so we listen to customer needs in order to provide the right solution. Whether they need a product or system, training and CPD, a full architectural design or just want to hear about the latest innovations; we're here to help. There aren't many challenges we haven't seen before, so our experience and can-do attitude means we always deliver on our promises. We co-innovate and come up with new ideas for intelligent, sustainable building solutions. By working with us, customers and partners can consider their challenges accepted, and solved.



## Quality with longevity

### Creating lasting value

We pride ourselves on delivering exceptionally high standards in our systems and solutions. With excellence and resilience as cornerstones of our business, we create long-lasting value for our customers, our employees and our community.

Our whole building envelope products and solutions mean buildings and renovations perform and are built to last. We create and deliver services that help customers optimise the quality and longevity of their designs, builds and processes.

The careers created and nurtured here encompass regular training, development and opportunity, helping our people to succeed, now and into the future.

## Global resources, local solutions

### The best of both worlds

Wienerberger Limited, as the UK operating business of Wienerberger AG, provides service on a local level, with the added benefits of global scale, resources and knowledge. The majority of the products we provide are manufactured locally from natural materials, and we have over 1,500 staff in the UK across 15 sites delivering high-quality service and solutions to our customers.

We give customers the benefits of local, global, proximity and scale; all to help support and drive your business forward.

## By your side

### Succeeding through partnership and teamwork

True partnership with customers is an easy thing to claim but rare in reality. We can genuinely say at Wienerberger that our customers are our partners and we are theirs.

We are committed to customer success, and by constantly listening to their requirements and challenges we grow with them, delivering products and services in line with their needs. Our architectural design service, Archigility, was based upon conversations with customers, and we are always bringing new and innovative solutions to the market.

As well as partnership with customers, we drive our service and our business forward through colleague collaboration: sharing challenges, successes and ideas. Every member of our team plays an essential role, and we have an open, inclusive culture based on teamwork.

# We are *Future-Builders*

For our business to be sustainable, we need to create enduring value – for us and for those around us. As well as providing product and service solutions for the challenges of climate change, biodiversity loss and resource scarcity in the built environment, Wienerberger Limited must become a net-zero emission, nature-positive business.

We want to positively impact the communities in which we live, work, source and sell, and conserve the natural resources upon which we all depend.

Therefore we invite our partners and communities to share their sustainability ambitions with us, so that we can innovate, learn, and move forward together.

From ideas to completion and beyond, we commit to supporting architects, designers, developers and merchants to create smarter, better-performing buildings and spaces that reduce our impact on the planet. We know the solutions need to be affordable and convenient to use.

Our sustainability strategy looks ahead to 2030 and we have already set workstreams in motion to help us to reach our goals. We urgently undertake these tasks with a sense of responsibility and commitment to tackle the crises of climate change, biodiversity loss and resource scarcity by building beyond the known.



# Our Sustainability Strategy

At Wienerberger Limited we're building beyond what we know to be possible today, and rethinking how we create value for our customers, our people and our communities. Our strategic priorities and ambitions for 2030 are outlined below.



## Safeguarding our planet

Tackling the issues of climate change, biodiversity loss and resource scarcity head-on



### Decarbonisation

We will have set a Science Based Target and established a net-zero (Scope 1 & 2) ceramic production line as a key milestone towards achieving net-zero emissions before 2050.

### Resource conservation

We will use lifecycle assessments to demonstrate we have reduced our demand for natural resources.

### Biodiversity promotion

We will use the Biodiversity Net Gain metric to demonstrate increased biodiversity across our land assets.



## Innovating for the future we want

Developing new products and services that reduce our impact on the planet



### Manufacturing processes

Our manufacturing processes will assist Wienerberger's transition to a net-zero emission, nature-positive company.

### Circular initiatives

We will have integrated circular economy principles into our business model by designing out waste across the whole product lifecycle.

### Product & service innovations

Our products and services will improve people's quality of life and promote efficient use of energy and water in the built environment.



## Moving forward together

Transitioning to a net-zero, nature-positive, equitable society together



### Our people

We will be able to demonstrate high levels of mental and physical wellbeing amongst employees, evidenced by our H&S reports and biannual employee surveys.

Our workforce and leaders will be representative of our local communities.

### Our partners

We will have curated a network of trusted partners to tackle the global crises of climate change, biodiversity loss and resource scarcity.

### Our communities

We will be able to demonstrate that Wienerberger adds value for communities through our Social Value Statement.

Underpinned by our behaviours (Commitment, Communication, Collaboration and Celebration) which necessitate ethical conduct and transparent reporting

# WHY CLAY?

## Understanding the natural material benefits

At Wienerberger we passionately believe in the benefits of building with clay. For us, it is the ideal raw material for long lasting, low impact construction projects. At the forefront of our industry for over 5,000 years, the advantages of clay are many and varied, covering every aspect of modern building.

### Economic

A building structure made of clay blocks can be constructed quickly, saving both time and money during construction. Due to the durability and stability of buildings comprising of clay materials, maintenance costs are low and assets typically achieve high resale values.

### Versatile

Clay building materials can be used almost anywhere: walls, façades, roofs, gardens, terraces and open spaces. They're also suitable for use within a range of projects, whether it's the construction of family homes, apartment blocks, offices or public buildings.

### Aesthetic

With a range of colours from traditional hues of red and blue through to bold black and whites, it's easy to create a unique project. The rough, smooth and glazed surfaces achievable with clay provide a variety of textures, while coloured mortar combinations enable endless design possibilities.

### Natural

All our blocks, facing bricks, roof tiles and pavers are considered natural products because they consist mainly of two simple raw materials: clay and water. All our clay building components are free of VOC pollutants and allergens, promoting healthy indoor air quality.









## BRING THE OUTSIDE IN

### **Paver slips are a perfect demonstration of clay's adaptability to modern architecture and design trends.**

Like brick slips, paver slips are thin sections of clay pavers that offer the same appearance as a full paver but that can be fitted, internally or externally, to a range of surfaces.

Whether you are creating commercial spaces such as cafés and hotels, roof gardens or residential projects, we offer a comprehensive and stylish range.

To find out more about Wienerberger Paver Slips visit:  
[www.wienerberger.co.uk/products/pavers/paver-slips](http://www.wienerberger.co.uk/products/pavers/paver-slips)



## BLEND S

**The beauty of clay paving is that each paver design can be installed on its own as a stunning landscaping solution or be combined with other shades to create a unique and eye-catching blend.**

With a wide range of colours, textures and sizes available in the Wienerberger clay paver collection, designers can unlock unlimited creative possibilities when designing their own bespoke mixture of pavers for a scheme.

To create a blend, make your selection from pavers in a spectrum of colours, including greys, browns, blacks, reds, oranges, buffs and creams. The natural colour variation within each paver design further enhances the overall visual effect. The colourfast qualities of natural clay will ensure that the tones chosen for each blend will continue to look their best for a lifetime.

Paver blends are an effective way of creating the right ambience for outdoor spaces. A bold, directional paving design featuring strong colours can be used to draw attention to a landmark or encourage the flow of foot traffic along a chosen route. Alternatively, a paver blend with a soft and subtle aesthetic that complements the surrounding architecture is ideal for public spaces where people can relax and socialise.

Wienerberger's dedicated landscape team are on hand to offer advice on how to achieve the perfect paver blend for a wide variety of projects and provide specialist support for large-scale schemes.



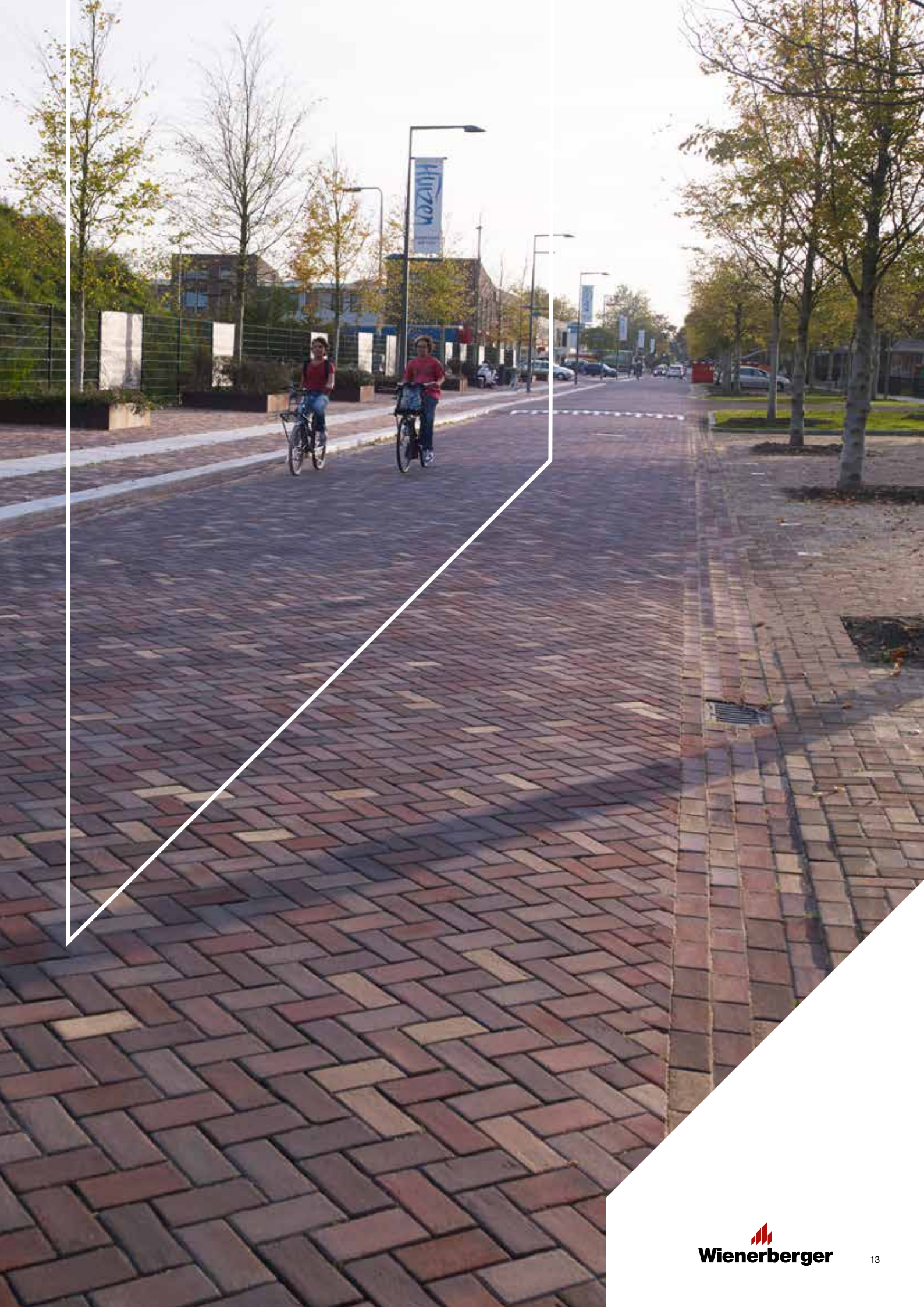





## TUMBLLED PAVERS

**If your project requires a more unique and varied aesthetic, whether for a heritage or traditional look, or a contemporary mixed texture effect, our Alder range of tumbled pavers is ideal.**

### Designed to Last

The range is manufactured to withstand heavy footfall and light vehicular traffic, making these pavers suitable for a range of domestic and commercial applications. The texture and contrast provide rustic style alongside fantastic longevity. Create a real legacy project with the durability and strength of clay.

### Character and Colour

Choose from a variety of colours and blends to define the aesthetics of your project. The entire Alder Paver range can be used for rigid or flexible laying, with the clay providing a natural colour fastness to lock in your visual composition.



## WATERSTRUCK PAVERS

**Where landscape design lends itself towards a diverse visual impression, waterstruck pavers are the ideal choice. Each paver takes on a subtly different shape or form, leading to a more natural or random textural effect.**

### Defined by Water

This well developed technique, which results from the use of water within the moulding and demoulding process, adds character and individuality to every paver. The pavers are produced unsanded, adding to the tactile impression of the landscaping.

### Flexible Performance

Waterstruck pavers can be laid using either bound or unbound construction. This durable solution is suitable for everything from domestic pedestrian to heavy vehicular traffic, unlocking a wealth of potential uses.





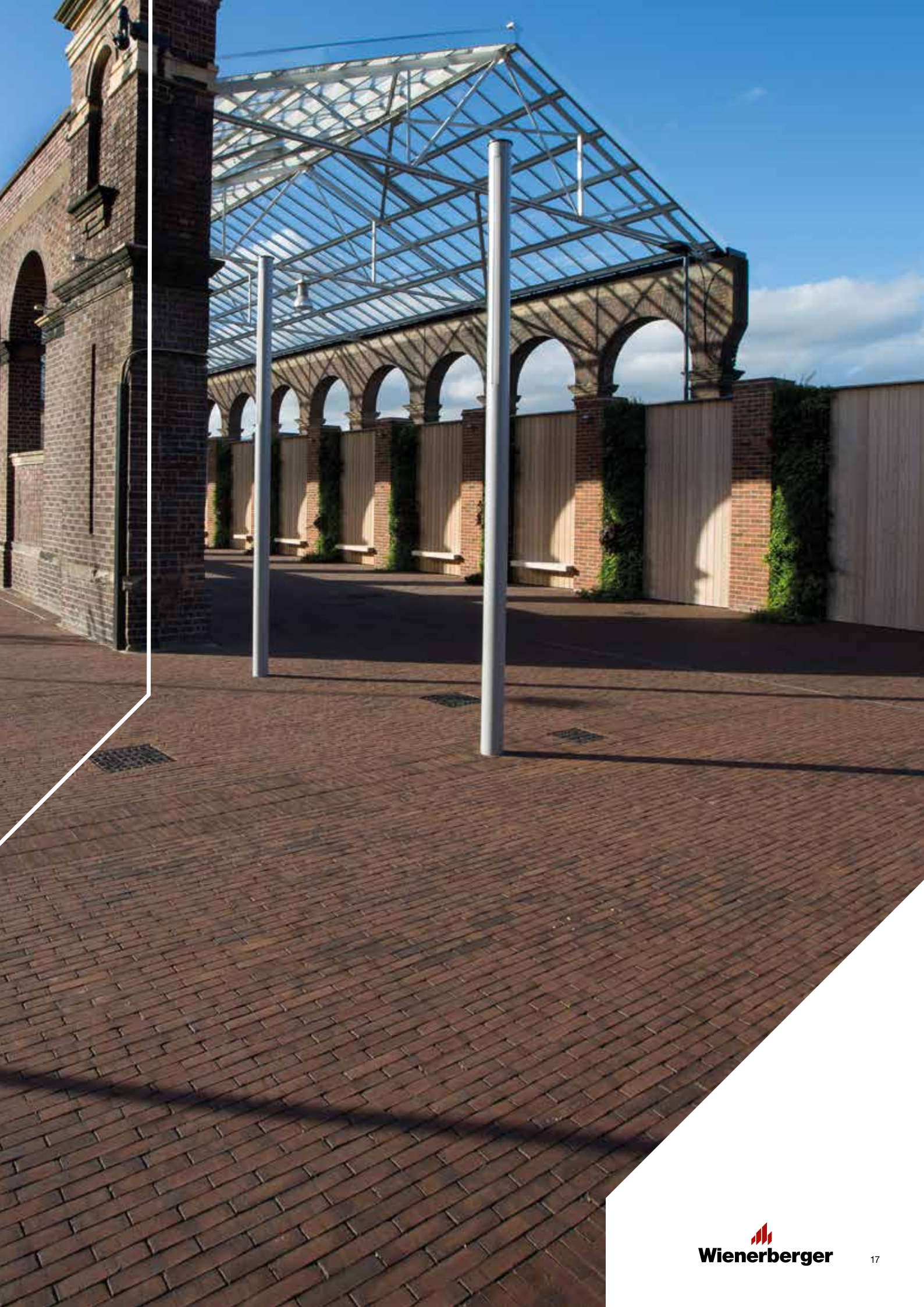

# PRODUCT PORTFOLIO

## Contents

Dutch Pavers	20-25
Alder UWF Pavers	26-27
62mm Range	28-29
Baggeridge Pavers	30-31
Diamond Pattern Pavers	32-33
KK80 Pavers	34-35
Sycamore Range	36-37
Sustainable Urban Drainage	38-39
Aquata Pavers	40-41

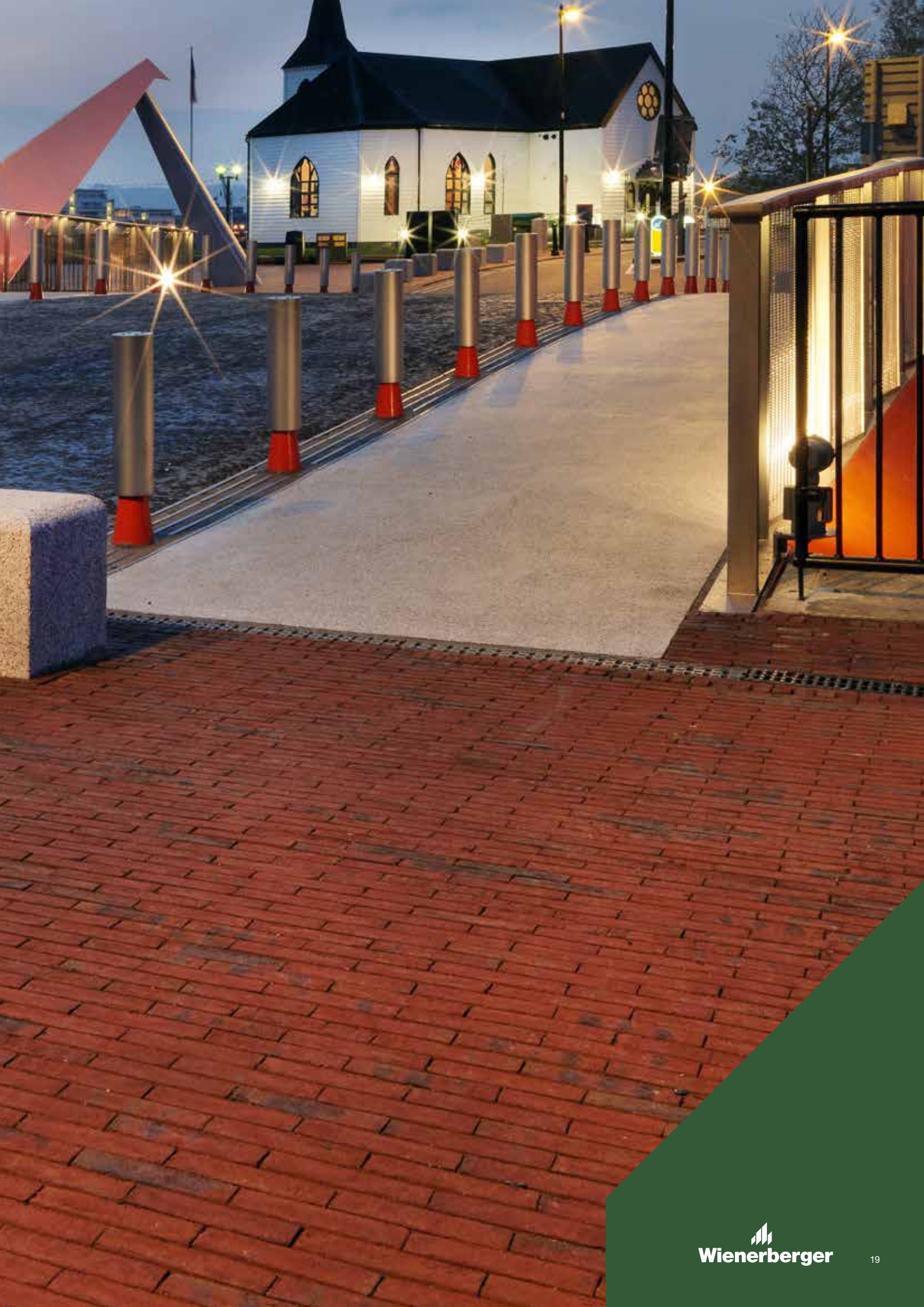

# DUTCH PAVERS



SUITABLE FOR  
HEAVY TRAFFIC

Wienerberger's Dutch collection gives designers and landscape architects the opportunity to achieve a distinctive geometric and unique aesthetic in large areas of urban paving. We offer mixed reds, browns, creams, greys and blacks.

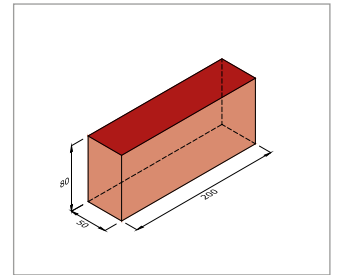
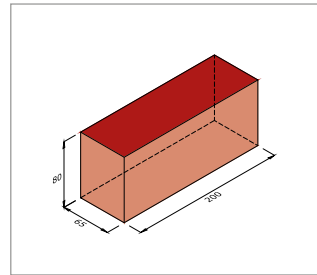

## Buff / Buff Multi



AURATON DF



AURATON WF



SIENA WF\*



SIENA DF\*



VARIA WATERSTRUCK DF\*



VARIA WATERSTRUCK WF\*



SIENA WF  
Seaburn Seafront, Sunderland

\* ALSO AVAILABLE IN TUMBLED, CONDITIONS APPLY

# DUTCH PAVERS

## Red



BRUNO WF  
Hartlepool



BRUNO DF



BRUNO WF



BRUNO WATERSTRUCK DF



BRUNO WATERSTRUCK WF



PAVIONA DF



PAVIONA WF

\* ALSO AVAILABLE IN TUMBLED, CONDITIONS APPLY

# DUTCH PAVERS

## Red Multi



HERNE DARK BRINDLED



KOLN RED MULTI



HERNE DARK BRINDLED  
The Yard, University of Roehampton



NOVOTON DF\*



NOVOTON WF\*



PADOVA



NOVOTON WATERSTRUCK WF\*



NOVOTON WATERSTRUCK DF\*



PADOVA DF



PADOVA WF



ROSA WATERSTRUCK DF\*



ROSA WATERSTRUCK WF\*

\* ALSO AVAILABLE IN TUMBLED, CONDITIONS APPLY

# DUTCH PAVERS

## Brown Multi



GALA WATERSTRUCK DF\*



GALA WATERSTRUCK WF\*



INCANA WATERSTRUCK DF\*



INCANA WATERSTRUCK WF\*



MASTIEK DF



MASTIEK WF



MASTIEK WATERSTRUCK DF



MASTIEK WATERSTRUCK WF



OLIVA WATERSTRUCK DF\*



OLIVA WATERSTRUCK WF\*



MASTIEK WATERSTRUCK

\* ALSO AVAILABLE IN TUMBLED, CONDITIONS APPLY

# DUTCH PAVERS

Grey / Black



BASALT DF



BASALT WF



NERO DF\*



NERO WF\*



NERO WATERSTRUCK DF\*



NERO WATERSTRUCK WF\*



NERO DF  
Hoogeveen, Netherlands

\* ALSO AVAILABLE IN TUMBLED, CONDITIONS APPLY



# DUTCH PAVERS

Colour group	Product name	Page number	Work size (mm)	Dimensional deviation (range)	Mean transverse breaking load	SRV	Abrasion	Durability	Pack size	Typical pack weight (kg)	Quantity per m <sup>2</sup>
Buff / Buff Multi	Auraton DF	20	200 x 65 x 80	R1	T4	U3	A2	FP100	824	1869	75
	Auraton WF	20	200 x 50 x 80	R1	T4	U3	A2	FP100	1132	1868	100
	Siena DF	20	200 x 65 x 80	R1	T4	U3	A2	FP100	720	1536	75
	Siena WF	20	200 x 50 x 80	R1	T4	U3	A2	FP100	960	1582	100
	Varia Waterstruck DF	20	200 x 65 x 80	R1	T4	U3	A2	FP100	612	1438	75
	Varia Waterstruck WF	20	200 x 50 x 80	R1	T4	U3	A2	FP100	752	1316	100
Red	Bruno DF	21	200 x 65 x 80	R1	T4	U3	A2	FP100	720	1536	75
	Bruno WF	21	200 x 50 x 80	R1	T4	U3	A2	FP100	1048	1507	100
	Bruno Waterstruck DF	21	200 x 65 x 80	R1	T4	U3	A2	FP100	660	1551	75
	Bruno Waterstruck WF	21	200 x 50 x 80	R1	T4	U3	A2	FP100	752	1316	100
	Paviona DF	21	200 x 65 x 80	R1	T4	U3	A2	FP100	720	1536	75
	Paviona WF	21	200 x 50 x 80	R1	T4	U3	A2	FP100	960	1507	100
Red Multi	Herne Dark Brindled	22	210 x 50 x 70	R1	T4	U3	A2	FP100	864	1296	90
	Koln Red Multi	22	210 x 50 x 70	R1	T4	U3	A2	FP100	864	1296	90
	Novoton DF	22	200 x 65 x 80	R1	T4	U3	A2	FP100	824	1869	75
	Novoton WF	22	200 x 50 x 80	R1	T4	U3	A2	FP100	1132	1868	100
	Novoton Waterstruck DF	22	200 x 65 x 80	R1	T4	U3	A2	FP100	612	1438	75
	Novoton Waterstruck WF	22	200 x 50 x 80	R1	T4	U3	A2	FP100	752	1316	100
	Padova DF	22	200 x 65 x 80	R1	T4	U3	A2	FP100	720	1536	75
	Padova WF	22	200 x 50 x 80	R1	T4	U3	A2	FP100	960	1507	100
	Rosa Waterstruck DF	22	200 x 65 x 80	R1	T4	U3	A2	FP100	628	1476	75
	Rosa Waterstruck WF	22	200 x 50 x 80	R1	T4	U3	A2	FP100	816	1428	100
Brown Multi	Gala Waterstruck DF	23	200 x 65 x 80	R1	T4	U3	A2	FP100	628	1476	75
	Gala Waterstruck WF	23	200 x 50 x 80	R1	T4	U3	A2	FP100	816	1428	100
	Incana Waterstruck DF	23	200 x 65 x 80	R1	T4	U3	A2	FP100	628	1476	75
	Incana Waterstruck WF	23	200 x 50 x 80	R1	T4	U3	A2	FP100	816	1428	100
	Mastiek DF	23	200 x 65 x 80	R1	T4	U3	A2	FP100	720	1536	75
	Mastiek WF	23	200 x 50 x 80	R1	T4	U3	A2	FP100	960	1507	100
	Mastiek Waterstruck DF	23	200 x 65 x 80	R1	T4	U3	A2	FP100	720	1536	75
	Mastiek Waterstruck WF	23	200 x 50 x 80	R1	T4	U3	A1	FP100	960	1507	100
	Oliva Waterstruck DF	23	200 x 65 x 80	R1	T4	U3	A2	FP100	628	1476	75
	Oliva Waterstruck WF	23	200 x 50 x 80	R1	T4	U3	A2	FP100	816	1428	100
Grey / Black	Basalt DF	24	200 x 65 x 80	R1	T4	U3	A2	FP100	720	1536	75
	Basalt WF	24	200 x 50 x 80	R1	T4	U3	A2	FP100	960	1507	100
	Nero DF	24	200 x 65 x 80	R1	T4	U3	A2	FP100	720	1536	75
	Nero WF	24	200 x 50 x 80	R1	T4	U3	A2	FP100	960	1594	100
	Nero Waterstruck DF	24	200 x 65 x 80	R1	T4	U3	A2	FP100	720	1536	75
	Nero Waterstruck WF	24	200 x 50 x 80	R1	T4	U3	A2	FP100	960	1594	100

# ALDER UWF PAVERS



SUITABLE FOR  
LIGHT VAN TRAFFIC

The characteristic features of the UWF range include a tumbled edge with sanded or waterstruck textures. The range is available in tones of red, brown and grey to blend perfectly within a variety of surroundings.

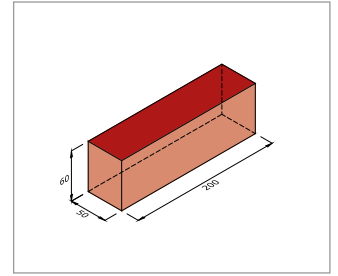

ARES UWF TUMBLED  
Guildford Crematorium Extension



ALFATON UWF TUMBLED



ARES UWF TUMBLED



ATLAS UWF TUMBLED



LOTIS UWF TUMBLED



ATLAS UWF TUMBLED  
Tatton Park RHS



RUSTON UWF TUMBLED



SUPRATON UWF TUMBLED



TRITON UWF TUMBLED

# ALDER UWF PAVERS

Product name	Work size (mm)	Dimensional deviation (range)	Mean transverse breaking load	SRV	Abrasion	Durability	Pack size	Typical pack weight (kg)	Quantity per m <sup>2</sup>
Alfaton UWF Tumbled	200 x 50 x 60	R1	T4	U3	A2	FP100	1040	1312	100
Ares UWF Tumbled	200 x 50 x 60	R1	T4	U3	A2	FP100	1040	1366	100
Atlas UWF Tumbled	200 x 50 x 60	R1	T4	U3	A2	FP100	1040	1366	100
Lotis UWF Tumbled	200 x 50 x 60	R1	T4	U3	A2	FP100	1040	1366	100
Ruston UWF Tumbled	200 x 50 x 60	R1	T4	U3	A1	FP100	1040	1250	100
Supraton UWF Tumbled	200 x 50 x 60	R1	T4	U3	A1	FP100	1040	1312	100
Triton UWF Tumbled	200 x 50 x 60	R1	T4	U3	A2	FP100	1040	1366	100



LOTIS UWF TUMBLED  
Pebble Mill, Birmingham

# 62MM RANGE



SUITABLE FOR  
LIGHT VAN TRAFFIC

A traditional, rectangular clay paver that's both practical and versatile, our paver is renowned for its durability and range of colours - giving the flexibility to work across a multitude of environments or landscapes.

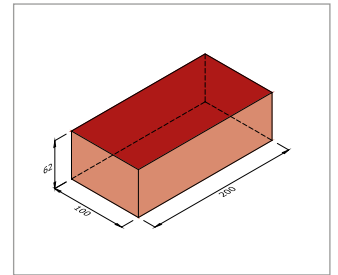

BLUE DRAGFACED CHAMFERED



BLUE DRAGFACED SQUARE EDGED



BOCHUM ORANGE  
Private Residence, Warrington



BOCHUM ORANGE MULTI 62MM\*



DORTMUND DARK MULTI 62MM



ESSEN RED 62MM\*



HANNOVER BUFF BRINDLED 62MM\*



MULTI BRINDLED DRAGFACED CHAMFERED



MUNSTER RED BRINDLED 62MM\*

\* Also available in 52mm

# 62MM RANGE

Product name	Work size (mm)	Dimensional deviation (range)	Mean transverse breaking load	SRV	Abrasion	Durability	Pack size	Typical pack weight (kg)	Quantity per m <sup>2</sup>
Blue Dragfaced Chamfered	200 x 100 x 62	R1	T4	U3	A3	FP100	396	1129	50
Blue Dragfaced Square Edged	200 x 100 x 62	R1	T4	U3	A3	FP100	396	1129	50
Bochum Orange Multi 62mm	200 x 100 x 62	R1	T4	U3	A3	FP100	560	1568	50
Dortmund Dark Multi 62mm	200 x 100 x 62	R1	T4	U3	A3	FP100	560	1568	50
Essen Red 62mm	200 x 100 x 62	R1	T4	U3	A3	FP100	560	1568	50
Hannover Buff Brindled 62mm	200 x 100 x 62	R1	T4	U3	A3	FP100	560	1568	50
Multi Brindled Dragfaced Chamfered	200 x 100 x 62	R1	T4	U3	A3	FP100	396	1133	50
Munster Red Brindled 62mm	200 x 100 x 62	R1	T4	U3	A3	FP100	560	1568	50



MUNSTER RED BRINDLED 62MM & BLUE DRAGFACED CHAMFERED  
Doddington Hall

# BAGGERIDGE PAVERS



SUITABLE FOR  
LIGHT VAN TRAFFIC

**Ideal for creating a more rustic, worn and weathered appearance, Baggeridge pavers are perfect for both domestic and commercial applications.**

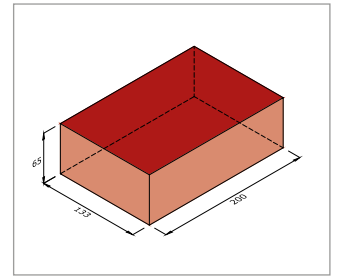
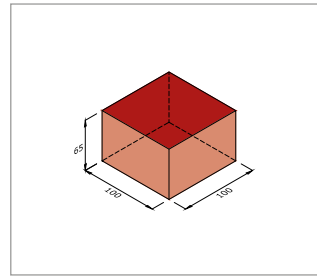

**BAGGERIDGE BLUE DRAGFACED SQUARE EDGED COBBLES**  
Spencer Road, Stoke-on-Trent



**BAGGERIDGE BLUE DRAGFACED SQUARE EDGED COBBLES\***



**BAGGERIDGE BLUE PROMENADE SQUARE EDGED**



**BAGGERIDGE BLUE TUMBLED COBBLES†**



**BAGGERIDGE RED PROMENADE SQUARE EDGED**



**BAGGERIDGE TELFORD PROMENADE SQUARE EDGED**

\* Baggeridge cobbles have been designed to be split on site.

† Due to the tumbling process these cobbles are already split and may require further dressing prior to laying.

# BAGGERIDGE PAVERS

Product name	Work size (mm)	Dimensional deviation (range)	Mean transverse breaking load	SRV	Abrasion	Durability	Pack size	Typical pack weight (kg)	Quantity per m <sup>2</sup>
Baggeridge Blue Dragfaced Square Edged Cobbles*	100 x 100 x 65	R1	T4	U3	A3	FP100	768	1152	100
Baggeridge Blue Promenade Square Edged	200 x 133 x 65	R1	T4	U3	A3	FP100	288	1200	37
Baggeridge Blue Tumbled Cobbles†	100 x 100 x 65	R1	T4	U3	A2	FP100	768	1152	100
Baggeridge Red Promenade Square Edged	200 x 133 x 65	R1	T4	U3	A3	FP100	288	1200	37
Baggeridge Telford Promenade Square Edged	200 x 133 x 65	R1	T4	U3	A3	FP100	288	1200	37



BAGGERIDGE BLUE PROMENADE SQUARE EDGED

# DIAMOND PATTERN PAVERS



SUITABLE FOR  
LIGHT VAN TRAFFIC

Available in either red or blue, our diamond patterned pavers are famed for their durability and hard wearing surface. The blue is a true blue unique to the clay source of their manufacture.

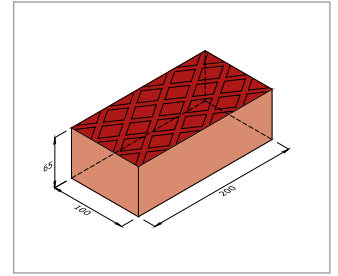

DIAMOND PATTERN BLUE



DIAMOND PATTERN BLUE



DIAMOND PATTERN RED



# DIAMOND PATTERN PAVERS

Product name	Work size (mm)	Dimensional deviation (range)	Mean transverse breaking load	SRV	Abrasion	Durability	Pack size	Typical pack weight (kg)	Quantity per m <sup>2</sup>
Diamond Pattern Blue	200 x 100 x 65	R1	T4	U3	A3	FP100	400	1136	50
Diamond Pattern Red	200 x 100 x 65	R1	T4	U3	A3	FP100	400	1136	50

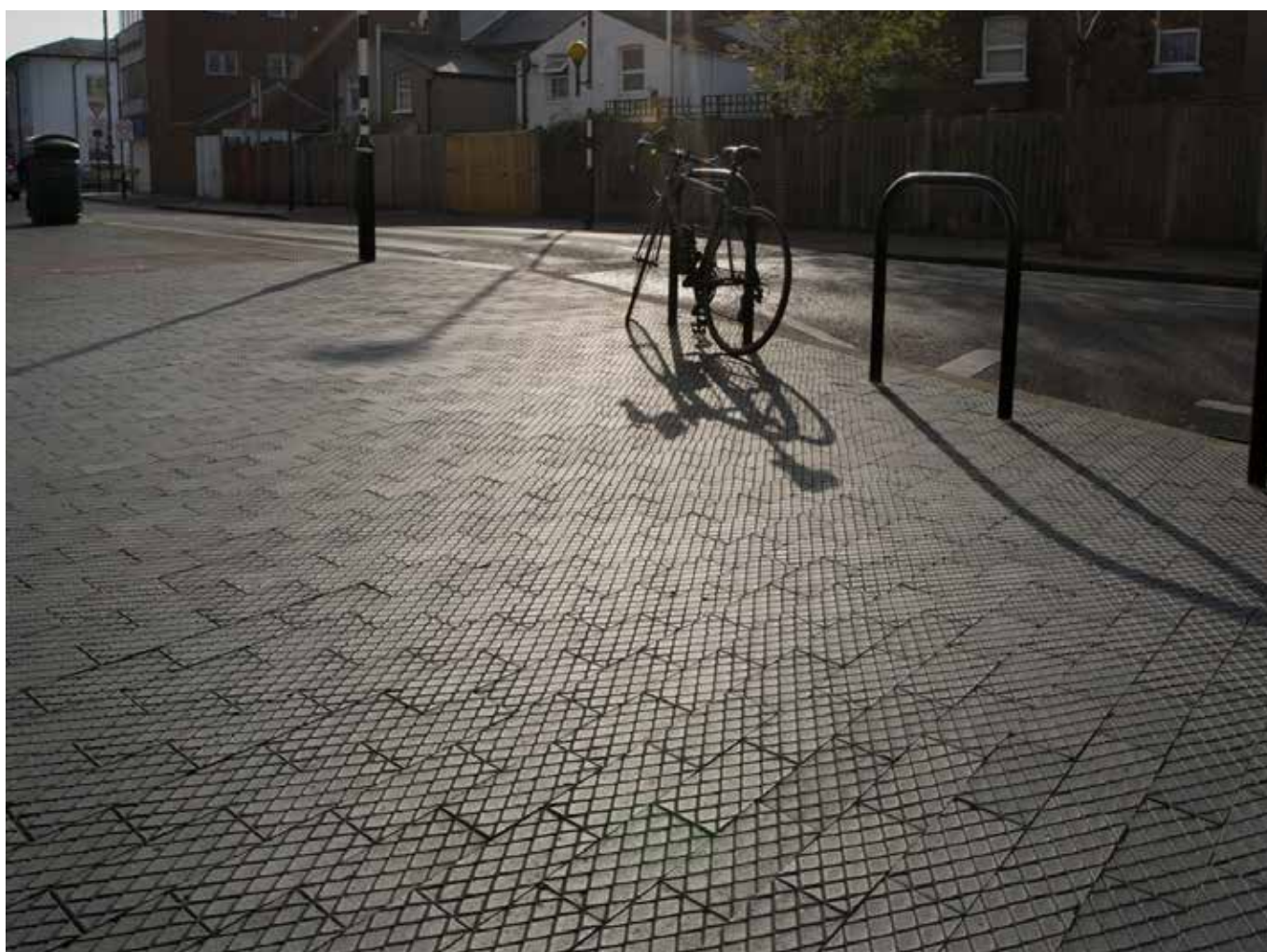

DIAMOND PATTERN BLUE  
Eltham Town Centre

# KK80 PAVERS



SUITABLE FOR  
HEAVY TRAFFIC

Developed from our existing Dutch range, these pavers will help meet the increasing demand for durable pavers that are suitable for all commercial applications.

Boasting the ability to be regularly subjected to heavy vehicular traffic, these pavers are colour fast, contributing to the fundamental resilience and long-term performance of the product - as well as making them a cost-effective solution suitable for a range of markets.

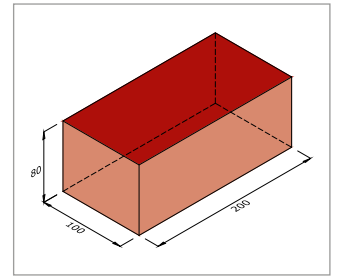

KK80 BRUNO



KK80 PAVIONA



KK80 NERO

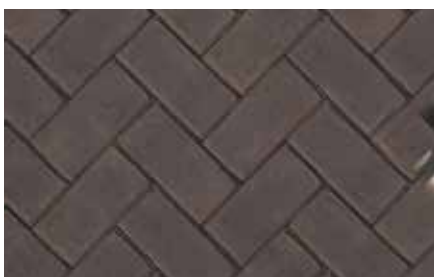

KK80 OMBER



KK80 PADOVA

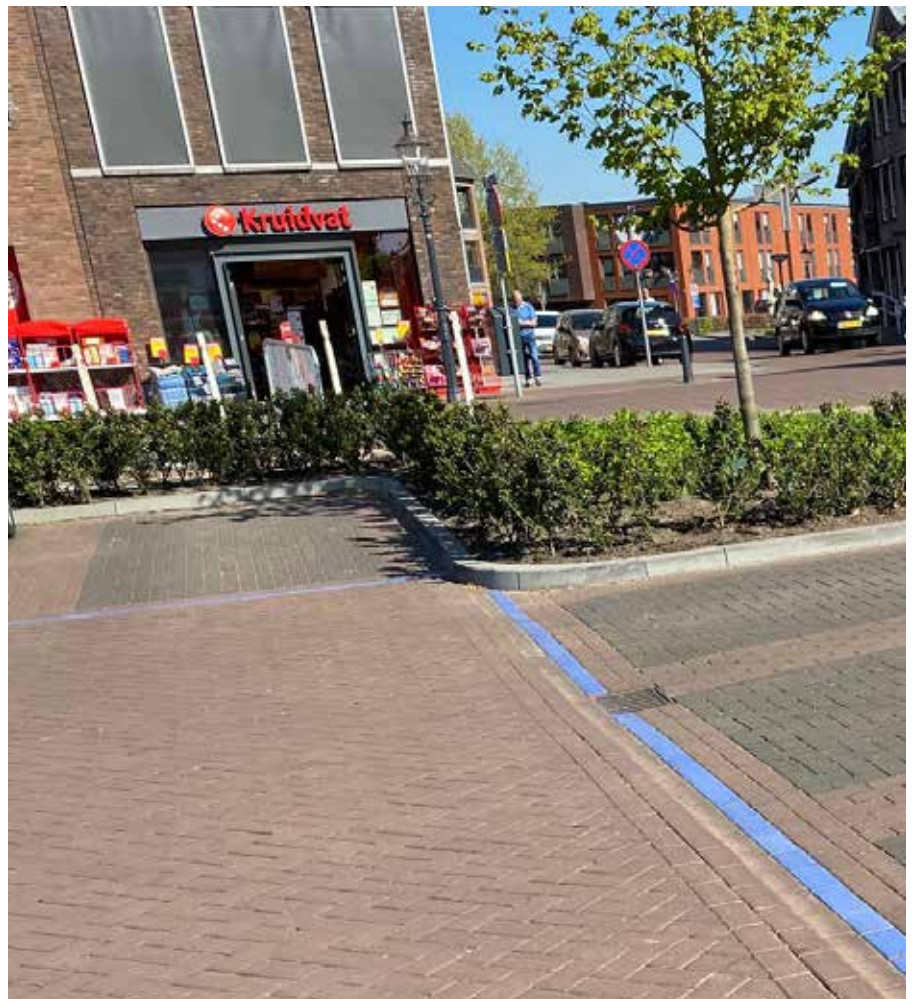

KK80 BRUNO  
Public road, Van Bergenpilen, Netherlands

# KK80 PAVERS

Product name	Work size (mm)	Dimensional deviation (range)	Mean transverse breaking load	SRV	Abrasion	Durability	Pack size	Typical pack weight (kg)	Quantity per m <sup>2</sup>
KK80 Bruno	200 x 100 x 80	R1	T4	U3	A3	FP100	500	1864	50
KK80 Nero	200 x 100 x 80	R1	T4	U3	A3	FP100	500	1864	50
KK80 Omber	200 x 100 x 80	R1	T4	U3	A3	FP100	500	1864	50
KK80 Padova	200 x 100 x 80	R1	T4	U3	A3	FP100	500	1864	50
KK80 Paviona	200 x 100 x 80	R1	T4	U3	A3	FP100	500	1864	50



KK80 NERO  
IJsselkade, Doesburg

# SYCAMORE RANGE



**A brand new range with a profile designed to complement domestic and light traffic environments. With 9 colours to choose from, any architectural style or reference can be reflected with efficiency and ease of installation in mind.**

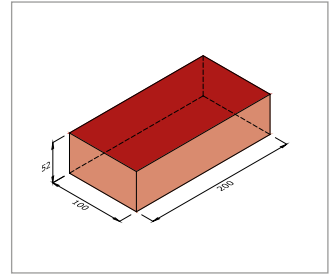

ARES 52MM



BOCHUM ORANGE MULTI 52MM\*



BREMEN BROWN 52MM



OLSBURG 52MM  
Private Residence, Dresden, Germany



ESSEN RED 52MM\*



HANNOVER BUFF BRINDLED 52MM\*



KELBRA 52MM



LOTIS 52MM



MUNSTER RED BRINDLED 52MM\*



OLSBURG 52MM

\* Also available in 62mm

# SYCAMORE RANGE

Product name	Work size (mm)	Dimensional deviation (range)	Mean transverse breaking load	SRV	Abrasion	Durability	Pack size	Typical pack weight (kg)	Quantity per m <sup>2</sup>
Ares 52mm	200 x 100 x 52	R1	T4	U3	A1	FP100	600	1525	50
Bochum Orange Multi 52mm	200 x 100 x 52	R1	T4	U3	A3	FP100	665	1449	50
Bremen Brown 52mm	200 x 100 x 52	R1	T4	U3	A3	FP100	665	1530	50
Essen Red 52mm	200 x 100 x 52	R1	T4	U3	A3	FP100	560	1568	50
Hannover Buff Brindled 52mm	200 x 100 x 52	R1	T4	U3	A3	FP100	665	1449	50
Kelbra 52mm	200 x 100 x 52	R1	T4	U3	A3	FP100	630	1450	50
Lotis 52mm	200 x 100 x 52	R1	T4	U3	A1	FP100	600	1523	50
Munster Red Brindled 52mm	200 x 100 x 52	R1	T4	U3	A3	FP100	665	1530	50
Olsburg 52mm	200 x 100 x 52	R1	T4	U3	A3	FP100	468	1077	50



BOCHUM ORANGE MULTI 52MM

# SUSTAINABLE URBAN DRAINAGE

**Risk of flooding in urban areas is a growing concern for Governments, local authorities, businesses and individuals. This is because heavy rainfall in recent years has demonstrated the hugely detrimental effect of flooding on property, public spaces, transport networks and the economy.**

In rural environments, 95% of rainwater is efficiently drawn away from the surface as it is reabsorbed into the ground, taken up by plants and trees, diverted to local waterways or it simply evaporates. This natural water cycle is disrupted in urban environments where there is less green space and permeable ground available. 95% of rainfall becomes excess surface water, which can cause flooding, pollution and erosion problems.

By taking rainwater management and SuDS technology into consideration early on in construction and landscape process, designers can improve the quality of life for those living and working in urban areas for years to come. This is a legal requirement and therefore everyone's responsibility in the landscape planning process.

To enable urban areas to cope with severe rainfall, Sustainable Urban Drainage Systems (SuDS) technology, such as permeable paving solutions, should be incorporated so surface water runoff can be controlled or harvested more effectively.



Before urbanisation



After urbanisation without use of drainage solution

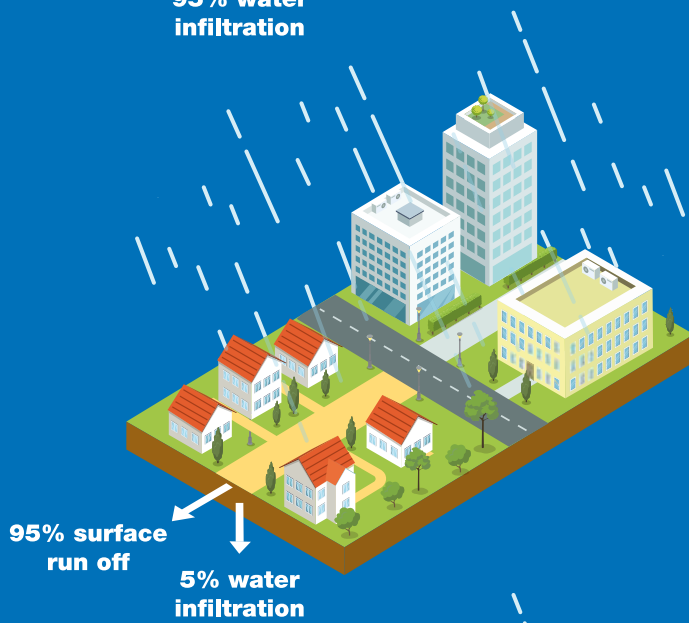

With permeable pavers

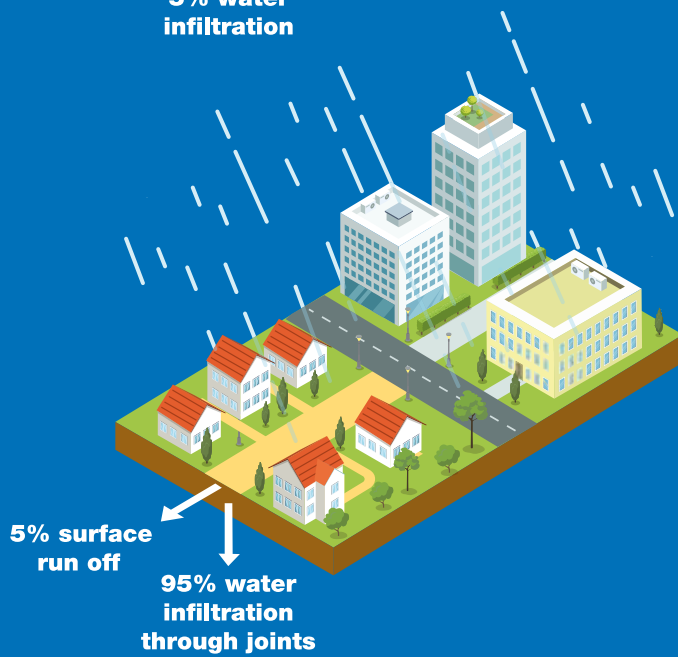

# AQUATA PAVERS



SUITABLE FOR  
HEAVY TRAFFIC

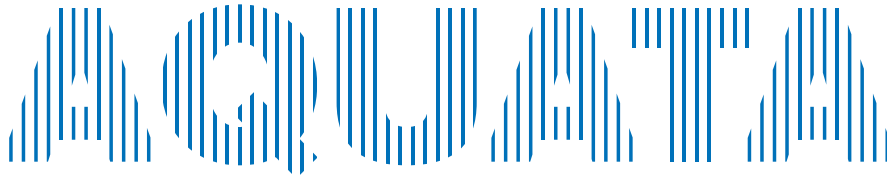

**The Aquata range of permeable clay pavers demonstrate that function and beautiful landscape design can go hand in hand.**

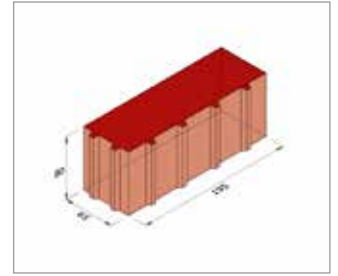

The successful drainage of excess surface water is a huge problem in urban areas where there is little green space and permeable ground. Aquata pavers offer a solution to this by providing a controlled method of draining away rainwater, whilst also embodying the performance and aesthetics of our standard clay pavers.

The purpose of Aquata pavers as an effective water drainage solution does not affect their versatility as a high-design landscaping option for commercial and domestic projects. Available in four colours – black, brown, grey and red – these durable Dutch style pavers can be laid in an array of patterns and mixed into stunning colour blends that will not fade.

Aquata pavers have been expertly engineered to encompass all the aesthetic appeal of the ever-popular Dutch style paver, whilst offering a high-performance water drainage solution. One hectare of Aquata pavers allows 20,000 litres per second per hectare to infiltrate through the joints of the pavers into the ground.

By providing designers with a permeable solution in a natural clay product, schemes can benefit from a strong, durable, colour through and low maintenance hard landscaping material. Available in a range of natural shades and offering design versatility thanks to the variety of possible laying patterns, colourfast Aquata clay pavers will keep their vibrant and rich tones even after exposure to extreme weather conditions.



AQUATA BLACK\*



AQUATA BROWN\*



AQUATA GREY\*



AQUATA RED\*

AQUATA GREY

\* ALSO AVAILABLE IN TUMBLED, CONDITIONS APPLY



# AQUATA PAVERS

Product name	Work size (mm)	Dimensional deviation (range)	Mean transverse breaking load	SRV	Abrasion	Durability	Pack size	Typical pack weight (kg)	Quantity per m <sup>2</sup>
Aquata Black	195 x 65 x 80	R1	T4	U3	A2	FP100	600	1260	78
Aquata Brown	195 x 65 x 80	R1	T4	U3	A2	FP100	600	1260	78
Aquata Grey	195 x 65 x 80	R1	T4	U3	A2	FP100	600	1260	78
Aquata Red	195 x 65 x 80	R1	T4	U3	A2	FP100	600	1260	78



**AQUATA BROWN**  
Dudzele Village Centre, Belgium

# ACCESSORIES

## Contents

Marker Pavers	44
Deterrent Pavers	45
Infill, Channel & Step Pavers	46-47
Kerbs	48-50
Tactile, Warning and Guidance Pavers	51





## ACCESSORIES

**We supply a comprehensive range of accessories to enhance commercial design schemes both aesthetically and functionally.**

**All accessories are engineered to the exacting standards of our core paving portfolio, and boast the same characteristic strength, durability and aesthetic value.**

### Range

A full selection that spans deterrent pavers, infill units, channel units, step units and units for assorted kerb types.

### Availability

Wienerberger holds stock, but the accessories may be on extended delivery during periods of high demand. Therefore, we advise that customers order as early as possible to ensure the products can be supplied in line with installation and construction programmes.

# MARKER PAVERS

Marker pavers are standard paving units that have been developed by Wienerberger for use in a wide range of applications, including: indicating traffic restrictions, marking car bays, and where the use of naturally contrasting paver colours is not permitted. These units are factory coated in yellow or white and treated with an anti-skid dressing.



**M.2 YELLOW MARKER PAVER - CHAMFERED**  
(also available in white)

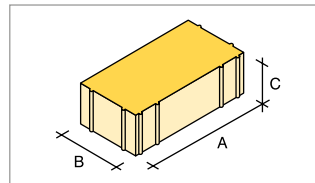

**M.1/M.2 MARKER PAVER\***  
Square Edged or Chamfered

Suitable for:

- Trafficked highways
- Definition or parking bays
- Locations where high visibility indicators are required



**M.3 STEP MARKER PAVER**  
(also available in red)

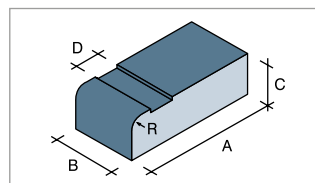

**M.3 STEP MARKER**  
Supplied ready for on-site grouting

To support the visually impaired, specially designed Step Marker Pavers provide a means of highlighting step nosings and are available in red or blue to complement paving and supplied for on-site application of infill grout by the contractor.

## Marker pavers - Dimensions (mm)

Code	Type	A	B	C	D	R
M.1	Marker Paver* - Square-edged	200	100	65	-	-
M.2	Marker Paver* - Chamfered	200	100	65	-	-
M.3	Step Marker Paver	215	102	65	55	25

\* The life of the coating will depend upon conditions of use

# DETERRENT PAVERS

Offering various levels of deterrence to restrict or prevent use by pedestrians, bicycles and supermarket trolleys or to discourage vehicle over-run, Deterrent Pavers are generally laid with alternating rows, or larger areas of standard pavers. They can also contribute to the overall aesthetic impact of a scheme through the contrast of light and shade afforded by their profiles, coupled with the use of colour.



D.1 SLIP-TOP DETERRENT PAVER



D.2 SHARP-TOP DETERRENT PAVER

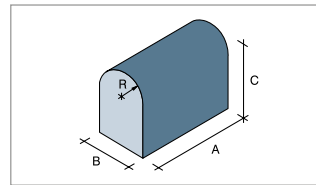

D.1 SLIP-TOP DETERRENT PAVER

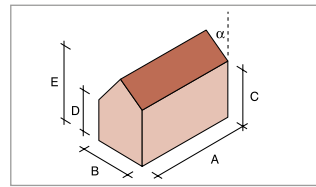

D.2 SHARP-TOP DETERRENT PAVER

**Note:**

In the interests of user safety, careful consideration should be given to the design and location of deterrent features.



D.4 STRETCHER RIDGED DETERRENT PAVER & D.3 HEADER RIDGED DETERRENT PAVER

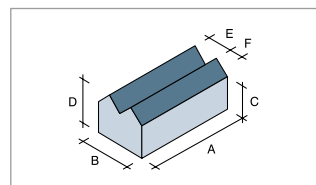

D.3 HEADER RIDGED DETERRENT PAVER

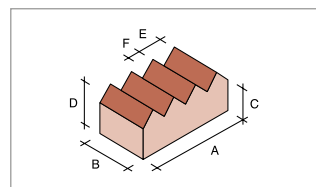

D.4 STRETCHER RIDGED DETERRENT PAVER

**Deterrent pavers - Dimensions (mm)**

Code	Type	A	B	C	D	E	F	R	$\alpha$
D.1	Slip-top Deterrent Paver	200	102	150	-	-	-	51	-
D.2	Sharp-top Deterrent Paver	200	102	114	83	150	-	-	45°
D.3	Header Ridged Deterrent Paver	200	100	65	25	50	25	-	-
D.4	Stretcher Ridged Deterrent Paver	200	100	65	25	50	25	-	-

# INFILL, CHANNEL & STEP PAVERS

## Infill Units

Offering a neat finish whilst minimising on-site cutting of small pieces, Infill Units are positioned adjacent to edge restraints or obstructions in a flexibly constructed pavement. They are available in blues and reds, with smooth or dragfaced surface textures to complement our full range of pavers.

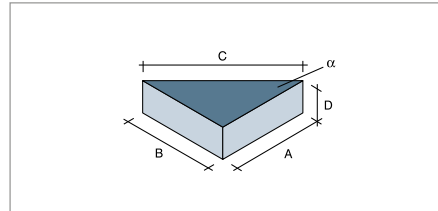

I.1.1/I.1.2 TRIANGLE

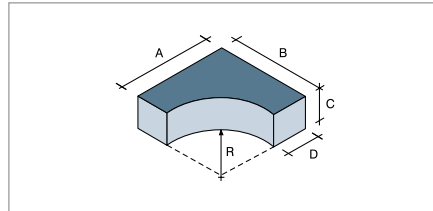

I.4.1/I.4.2 OBSTRUCTION SURROUND  
Designed for rigid laying

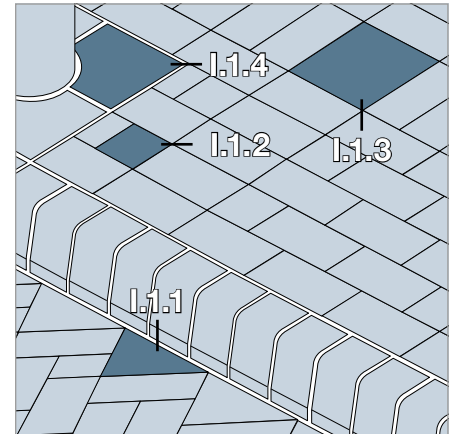

INFILL UNITS

Infill Units - Dimensions (mm)									
Code	Type	Edge Detail	A	B	C	D	E	R	$\alpha$
I.1.1	Triangle	Square-edged	187	187	264	65	-	-	45°
I.1.2	Triangle	Chamfered	187	187	264	65	-	-	45°
I.4.1	Obstruction Surround	Square-edged	194	194	65	-	-	varies to order	
I.4.2	Obstruction Surround	Chamfered	194	194	65	-	-	varies to order	

The radius on Obstruction Surrounds should not exceed 140mm and should be specified 10mm larger than the obstruction radius. Non-circular Obstruction Surrounds are available to order. Infill units are available either square-edged or chamfered.

## Step Units

Nosing Units feature rounded leading edges to minimise chipping, whilst Riser/Tread make-up units are faced on two headers, one stretcher and one bed face. Tactile Pavers can be used adjacent to flights of steps and step markers to highlight step nosings for the visually impaired.

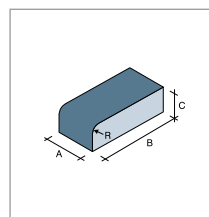

S.1 HEADER NOSING

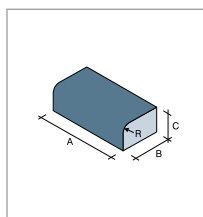

S.2 STRETCHER NOSING

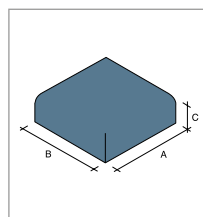

S.3.2 CORNER NOSING

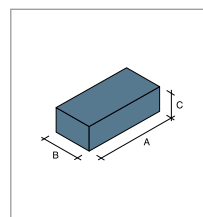

S.4 RISER/TREAD MAKE-UP

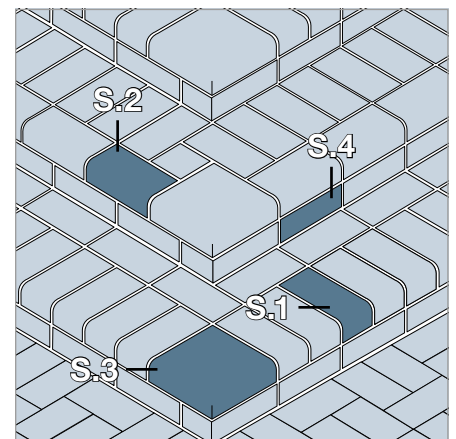

STEP UNITS

Step Units - Dimensions (mm)					
Code	Type	A	B	C	R
S.1	Header Nosing	102	215	65	25
S.2	Stretcher Nosing	215	105	65	25
S.3.1	Corner Nosing	215	102	65	25
S.3.2	Corner Nosing	215	215	65	25
S.4	Riser/Tread Make-up	215	102	65	-

# INFILL, CHANNEL & STEP PAVERS

## Channel Units

Typically used to direct surface water run-off to suitable outlets, these Channel Units feature a dished profile, which is compatible with popular dished gully outlets.

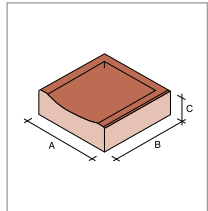

C.2 CHANNEL STOP END

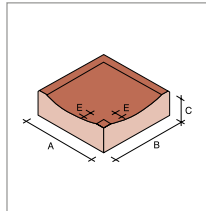

C.3 CHANNEL CORNER

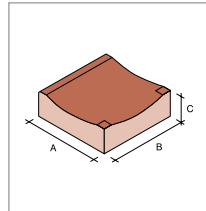

C.4 CHANNEL T-JUNCTION

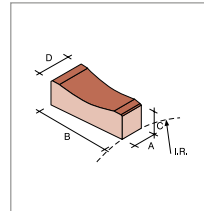

C.5 RADIUS CHANNEL

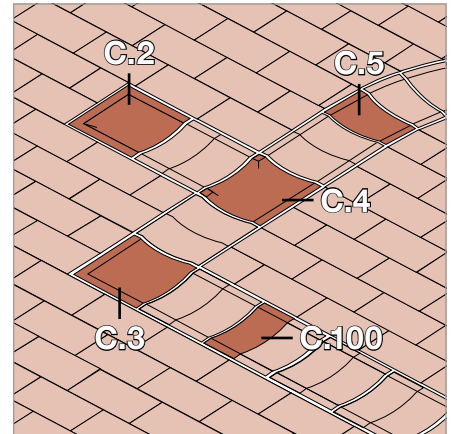

CHANNEL UNITS

### Channel Units - Dimensions (mm)

Code	Type	A	B	C	D	E	I.R. Internal Radius	Approx No. per ¼ Circle
C.100	Channel	100	200	65	12	20	-	-
C.200	Channel	200	200	65	12	20	-	-
C.2	Channel Stop End	200	200	65	-	-	-	-
C.3	Channel Corner	200	200	65	-	-	-	-
C.4	Channel T-Junction	200	200	65	-	-	-	-
C.5.1	Radius Channel	61	200	65	90	-	500	11
C.5.2	Radius Channel	74	200	65	90	-	1000	19
C.5.3	Radius Channel	78	200	65	90	-	1500	27
C.5.4	Radius Channel	81	200	65	90	-	2000	35
C.5.5	Radius Channel	82	200	65	90	-	2500	43

Available in  
red and blue



# KERBS

## Kerb Units

Adding visual definition to an area, kerbs in a paving scheme perform a number of functions including creating edge restraint details, delineating areas for vehicular and pedestrian use, and deterring over-riding by vehicles. Allowing kerbs to be constructed to suit the demands of anticipated levels and types of traffic, while maintaining the aesthetic coherence of a scheme, Kerb Units are offered in a choice of profile and depth of upstand, with units to achieve crossovers, corners and radii.

## Boot Kerbs

The Boot Kerb should be laid in a vertical orientation for heavily trafficked areas, although it can also be laid horizontally for use in lightly trafficked areas. The units may also act as a transition between paving and brickwork, with brickwork being built directly on them.

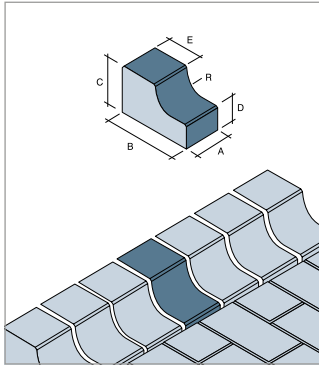

BK.100 BOOT KERB

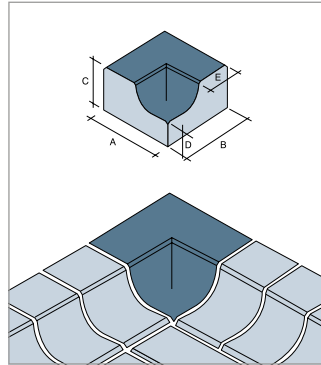

BKI.9 BOOT KERB INTERNAL CORNER

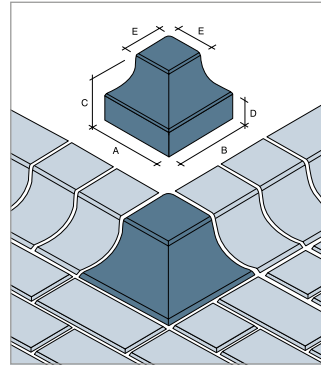

BKE.10 BOOT KERB EXTERNAL CORNER

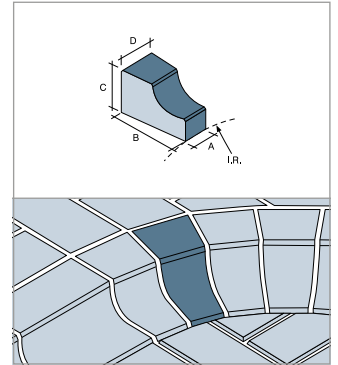

BKI.11 INTERNAL RADIUS BOOT KERB

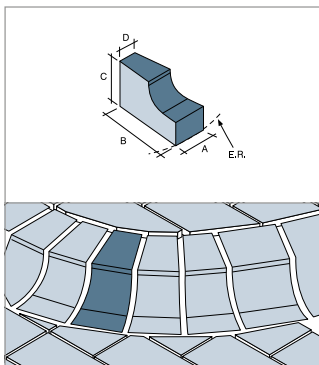

BKE.12 EXTERNAL RADIUS BOOT KERB

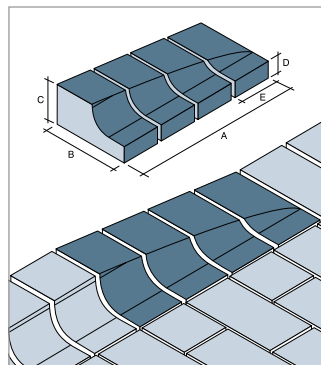

BK.13 BOOT DROP KERB SET  
(left & right hand)

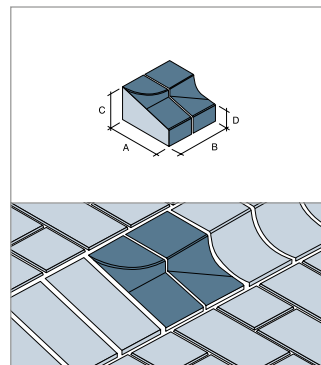

BK.15 BOOT TO CROSSOVER  
TRANSITION (left & right hand)

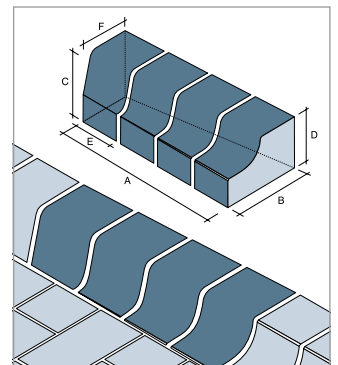

BK.16 BOOT TO HALF BATTER KERB  
TRANSITION (left & right hand)

### Boot Kerb Units - Dimensions (mm)

Code	Type	A	B	C	D	E	F	R	Radius I.R./E.R.	Approx No. per ¼ Circle	α
BK.100	Boot Kerb	100	200	125	65	103	-	50	-	-	-
BKI.9	Boot Kerb Internal Corner	200	200	125	65	103	-	-	-	-	-
BKE.10	Boot Kerb External Corner	200	200	125	65	103	-	-	-	-	-
BKI.11.1	Boot Kerb Internal Radius	61	200	125	90	-	-	-	500	11	-
BKI.11.2	Boot Kerb Internal Radius	74	200	125	90	-	-	-	1000	19	-
BKI.11.3	Boot Kerb Internal Radius	78	200	125	90	-	-	-	1500	27	-
BKI.11.4	Boowt Kerb Internal Radius	81	200	125	90	-	-	-	2000	35	-
BKI.11.5	Boot Kerb Internal Radius	83	200	125	90	-	-	-	2500	43	-
BKE.12.1	Boot Kerb External Radius	90	200	125	49	-	-	-	500	8	-
BKE.12.2	Boot Kerb External Radius	90	200	125	70	-	-	-	1000	16	-
BKE.12.3	Boot Kerb External Radius	90	200	125	77	-	-	-	1500	24	-
BKE.12.4	Boot Kerb External Radius	90	200	125	80	-	-	-	2000	32	-
BKE.12.5	Boot Kerb External Radius	90	200	125	82	-	-	-	2500	39	-
BK.13	Boot Drop Kerb Set	430	200	125	65	100	-	-	-	-	-
BK.15	Boot to Crossover Transition	200	200	125	65	-	-	-	-	-	-
BK.16	Boot To Half Batter Kerb Transition	430	200	170	125	100	125	-	-	-	-



# KERBS

## Cant and Bullnose Kerbs

Cant and Bullnose Kerbs are only suitable for very lightly trafficked areas. Purpose made returns and drop sets are available to order.

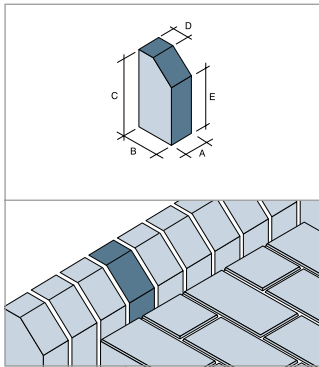

AN.5 SINGLE CANT

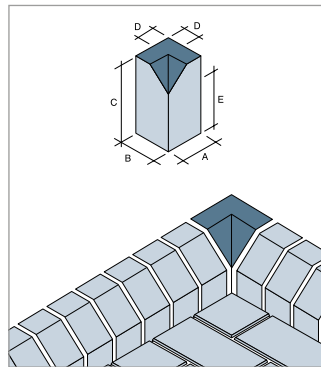

SD.2 SINGLE CANT  
INTERNAL RETURN ON END

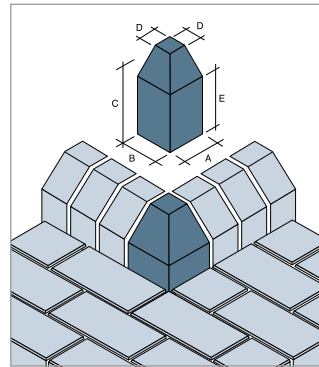

SD.3 SINGLE CANT  
EXTERNAL RETURN ON END

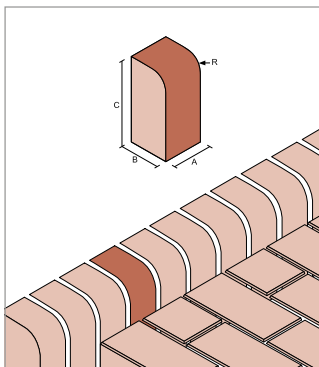

BN.1 SINGLE BULLNOSE

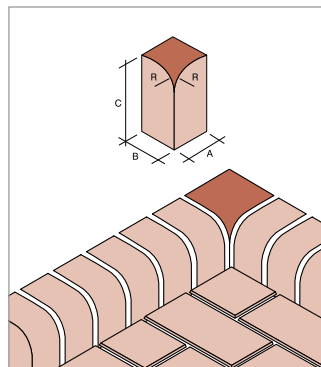

BN.8 SINGLE BULLNOSE  
INTERNAL RETURN ON END

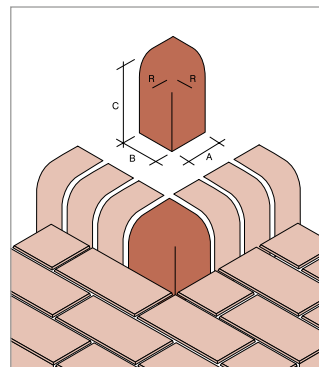

K.22 SINGLE BULLNOSE  
EXTERNAL RETURN ON END

### Cant and Bullnose Kerb Units - Dimensions (mm)

Code	Type	A	B	C	D	E	F	R	Radius I.R./E.R.	Approx No. per ¼ Circle	α
AN.5.1	Single Cant	65	102	215	46	159	-	-	-	-	-
AN.5.2	Single Cant	65	102	215	60	173	-	-	-	-	-
SD.2.1	Single Cant Internal Return on End	102	102	215	46	159	-	-	-	-	-
SD.2.2	Single Cant Internal Return on End	102	102	215	60	173	-	-	-	-	-
SD.3.1	Single Cant External Return on End	102	102	215	46	159	-	-	-	-	-
SD.3.2	Single Cant External Return on End	102	102	215	60	173	-	-	-	-	-
BN.1.2	Single Bullnose	65	102	215	25	-	-	-	-	-	-
BN.2.2	Single Bullnose	65	102	215	51	-	-	-	-	-	-
BN.8.3	Single Bullnose Internal Return On End	102	102	215	25	-	-	-	-	-	-
BN.8.4	Single Bullnose Internal Return On End	102	102	215	51	-	-	-	-	-	-
K.22.1	Single Bullnose External Return On End	102	102	215	25	-	-	-	-	-	-
K.22.2	Single Bullnose External Return On End	102	102	215	51	-	-	-	-	-	-

Available in  
red and blue



# KERBS

## Crossover Kerbs

Typically used to facilitate access for vehicular or other wheeled traffic where the general run of kerbing is an upstand kerb, the Crossover Kerb may also be used as a kerb in its own right. Alternative angles of slope are available to order.

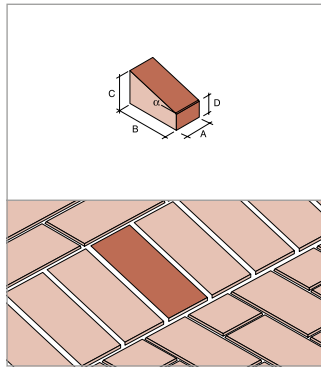

CK.1 CROSSOVER KERB

## Half Batter Kerbs

The Half Batter Kerb is intended for vertical installation but may also be laid horizontally depending on the depth of upstand and visual appearance required. In such cases, purpose-made returns and drop sets are available to order.

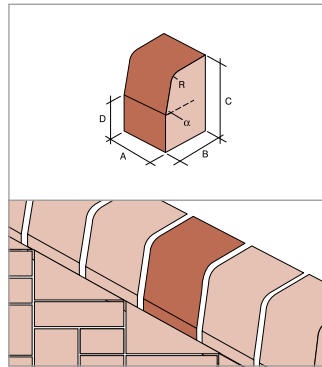

HB.200 HALF BATTER KERB

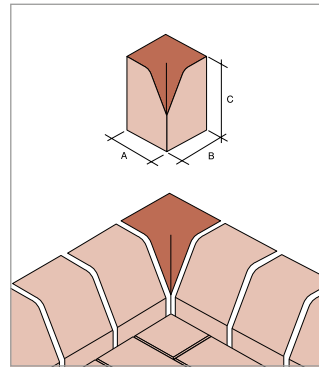

HBI.2 HALF BATTER KERB  
INTERNAL CORNER

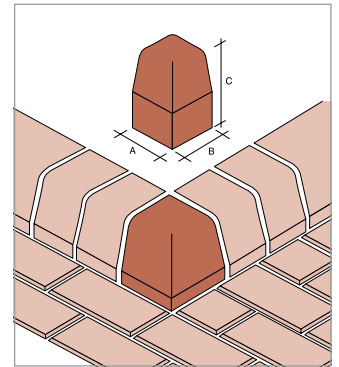

## Flush Kerbs

Typically used at a drop kerb position in conjunction with a Half Batter Drop Kerb Set, the Flush Kerb may also be used as a kerb or edging in its own right.

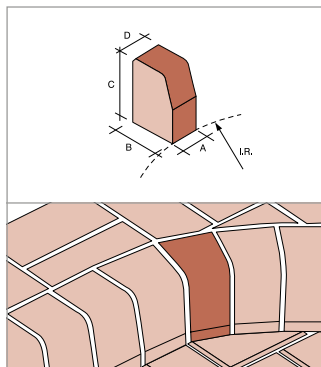

HBI.4 INTERNAL RADIUS  
HALF BATTER KERB

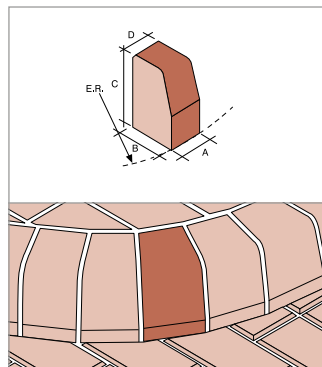

HBE.5 EXTERNAL RADIUS  
HALF BATTER KERB

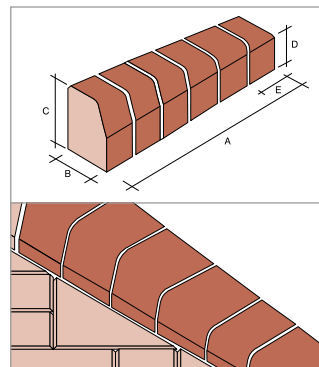

HB.6 HALF BATTER DROP KERB SET  
(left & right hand)

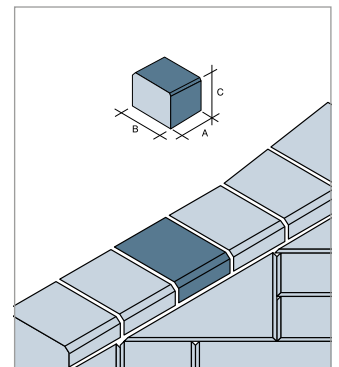

FK.7 FLUSH KERB

### Crossover, Half Batter and Flush Kerbs - Dimensions (mm)

Code	Type	A	B	C	D	E	F	R	Radius I.R./E.R.	Approx No. per ¼ Circle	α
CK.1	Crossover Kerb	100	200	125	65	-	-	-	-	-	17°
HB.100	Half Batter Kerb	100	125	200	100	-	-	18	-	-	76°
HBI.2	Half Batter Kerb - Internal Corner	125	125	200	-	-	-	-	-	-	-
HBE.3	Half Batter Kerb - External Corner	125	125	200	-	-	-	-	-	-	-
HBI.4.1	Half Batter Kerb - Internal Radius	68	125	200	88	-	-	-	500	10	-
HBI.4.2	Half Batter Kerb - Internal Radius	77	125	200	88	-	-	-	1000	18	-
HBI.4.3	Half Batter Kerb - Internal Radius	74	125	200	81	-	-	-	1500	28	-
HBI.4.4	Half Batter Kerb - Internal Radius	75	125	200	80	-	-	-	2000	37	-
HBI.4.5	Half Batter Kerb - Internal Radius	75	125	200	80	-	-	-	2500	46	-
HBE.5.1	Half Batter Kerb - External Radius	77	125	200	55	-	-	-	500	9	-
HBE.5.2	Half Batter Kerb - External Radius	82	125	200	71	-	-	-	1000	17	-
HBE.5.3	Half Batter Kerb - External Radius	74	125	200	67	-	-	-	1500	28	-
HBE.5.4	Half Batter Kerb - External Radius	75	125	200	70	-	-	-	2000	37	-
HBE.5.5	Half Batter Kerb - External Radius	75	125	200	71	-	-	-	2500	46	-
HB.6	Half Batter Kerb Drop Set	650	125	200	100	100	-	-	-	-	-
FK.7	Flush Kerb	100	125	100	-	-	-	-	-	-	17°

# TACTILE, WARNING AND GUIDANCE PAVERS



T.3 CORDUROY PAVER



T.6 DIRECTIONAL GUIDANCE PAVER

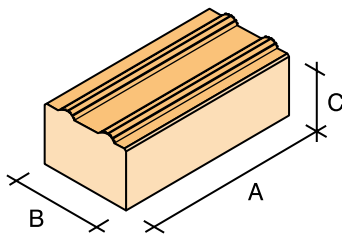

T.3 CORDUROY PAVER

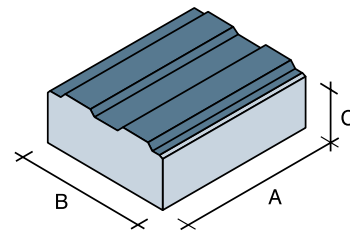

T.6 DIRECTIONAL GUIDANCE PAVER

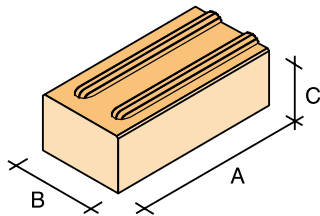

T.4 CORDUROY PAVER - STOP END

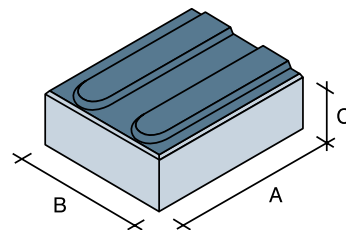

T.7 DIRECTIONAL GUIDANCE PAVER - STOP END

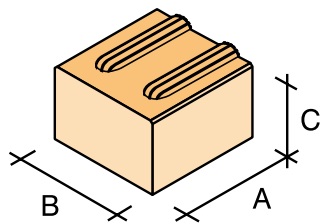

T.5 CORDUROY PAVER - HALF STOP END

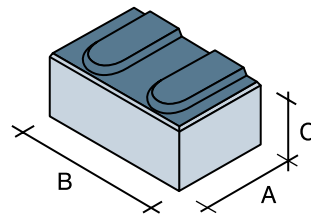

T.9 DIRECTIONAL GUIDANCE PAVER - HALF STOP END

## Tactile pavers - Dimensions (mm)

Code	Type	A	B	C
T.3	Corduroy Paver	200	100	65
T.4	Corduroy Paver - Stop End	200	100	65
T.5	Corduroy Paver - Half Stop End	100	100	65
T.6	Directional Guidance Paver	200	160	65
T.7	Directional Guidance Paver - Stop End	200	160	65
T.9	Directional Guidance Paver - Half Stop End	100	160	65

# LAYING PATTERNS

A key part of the creativity and aesthetic potential of clay pavers is in the laying patterns.

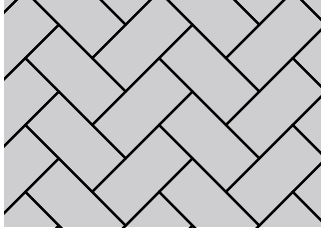

HERRINGBONE 45 DEGREE -  
COMMERCIAL

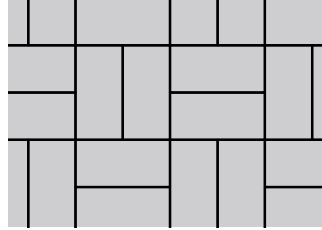

BASKET WEAVE (2 FACE AND 3 FACE) -  
PEDESTRIAN

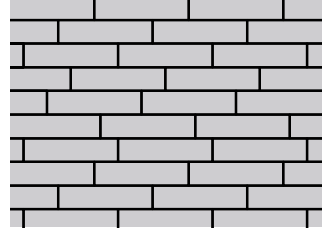

STAGGERED BOND -  
PEDESTRIAN

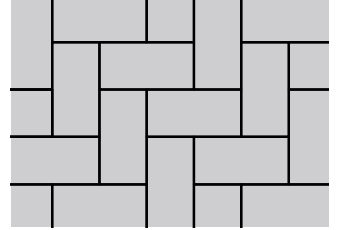

HERRINGBONE 90 DEGREE -  
COMMERCIAL

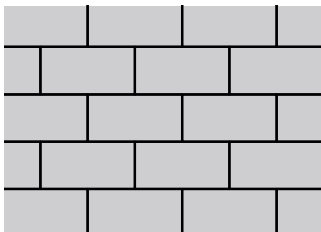

RUNNING BOND COURSE -  
PEDESTRIAN

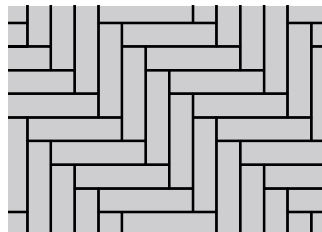

CHEVRON

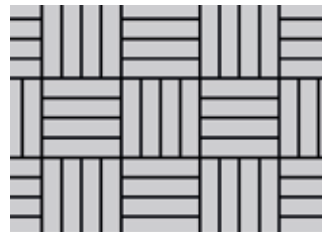

DUTCH PAVERS WF

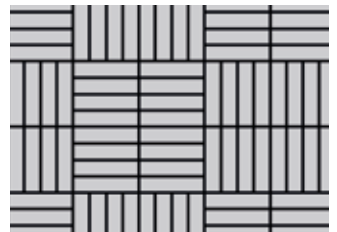

DUTCH PAVERS WF



# INSTALLATION AND DESIGN GUIDANCE

## Technical Characteristics and Properties to BS EN 1344:2013. Individual product information available in Paver Index.

### Laying

The sub-grade should be prepared to the engineer's required specification and the sub-base should normally be a well compacted Type 1 to the designed thickness taking into account traffic loadings and suitability of the subgrade.

### Edge Restraint

It is imperative that solid edge restraints are provided along the perimeter of all paved areas to restrict lateral movement (creep) resulting from the action of deceleration and turning forces. They should be adequate to prevent the escape of the bedding course material beneath the paver surface.

When using kerbs ensure the concrete bed/haunch has matured before any compaction is undertaken.

### Cutting Clay Paving

Clay paving should be cut using a multi bladed mechanical paver splitter or bench mounted water cooled power saw to achieve the best finish. Clay paving should not be cut to less than a quarter of the original size along the length of the paver and never cut across the width – when required complimentary fittings and inboard cutting should be used.

### Drainage

Sufficient cross-fall should be provided to prevent standing water on all block paved surfaces.

### Unpacking the Pavers

In order to obtain the correct blend of colour, mix from a minimum of 3 packs. The paver packs require unpacking vertically - not horizontally, layer-by-layer. This will equally distribute minor size variations of the pavers over the entire pavement, and will help to maintain the correct bond pattern. Damaged or broken pavers must not be used although they can be used as cut pieces for infilling.

### Bedding Course and Paving

Bedding course material for conventional pavements should be naturally occurring sand and should be selected in accordance with the recommendations given in BS7533: Part 3 : 2005 – Code of Practice for Laying Precast Concrete Paving Blocks and Clay Pavers for Flexible Pavements.

Bedding sand is both the strength and weakness of a flexible clay pavement as it provides the interlock that ensures that pavers can accommodate extreme loading.

Bedding course material to be 25-40mm compacted thickness over the specified thickness of sub-base. The use of a geotextile below bedding course to prevent migration of sand may be advisable if the sub-base is open textured.

Pavers should be laid in the designated bond pattern working from an edge restraint or existing laying face edge. Mechanical force should not be used to bring pavers into intimate contact and should be laid such that a joint width of 2 to 5mm forms between each paver with a target joint width of 3mm thus ensuring there is no point contact between units. The laying of any clay paver, with or without nibs, will require the opening or closing up of joints to maintain good lines throughout the work due to the tolerances of a natural clay product.

### Compaction of Pavers

When a sufficient area of pavers has been laid - and before starting the vibration - a fine kiln dried silica jointing sand must be brushed into the joints. The pavers are compacted onto the sand bed using a vibrating plate compactor with a rubber sole-plate to any avoid damage to the surface.

After compaction, any damaged pavers must be immediately removed and replaced. Any unevenness or differences in height must be adjusted.

### Joint-filling







































After compaction, a further application of fine kiln dried silica sand is brushed into the joints until all joints are entirely full. Failure to ensure joints are full before opening up the area to traffic may cause movement and loosening of the paved surface. Upon satisfactory completion traffic may be permitted to use the pavement. Do not use high powered suction cleaners on newly laid areas of flexible paving.

### Maintenance

Wienerberger clay pavers are resistant to chemicals and cleaning fluids. Pavements using clay pavers can be cleaned using biodegradable detergents. Mechanical or high water pressure cleansing operations will require re-sanding of the joints.

For further information please contact the Wienerberger design services team.











































# INDEX

Product name	Range	Page number	Suitable for	Work size (mm)	Abrasion	Pack quantity	Typical pack weight	Quantity per m <sup>2</sup>	Location/ collection point
Alfaton UWF Tumbled	Alder	26		200 x 50 x 60	A1	1040	1312	100	Hull/Purfleet
Aquata Black	Aquata	40		195 x 65 x 80	A2	600	1405	78	Hull/Purfleet
Aquata Brown	Aquata	40		195 x 65 x 80	A2	600	1405	78	Hull/Purfleet
Aquata Grey	Aquata	40		195 x 65 x 80	A2	600	1405	78	Hull/Purfleet
Aquata Red	Aquata	40		195 x 65 x 80	A2	600	1405	78	Hull/Purfleet
Ares - 52mm	Sycamore	36		200 x 100 x 52	A1	600	1525	50	Kingsbury
Ares UWF Tumbled	Alder	26		200 x 50 x 60	A2	1040	1366	100	Hull/Purfleet
Atlas UWF Tumbled	Alder	26		200 x 50 x 60	A2	1040	1366	100	Hull/Purfleet
Auraton DF	Dutch	20		200 x 65 x 80	A2	824	1868	75	Hull/Purfleet
Auraton WF	Dutch	20		200 x 50 x 80	A2	1132	1868	100	Hull/Purfleet
Baggeridge Blue Dragfaced Square Edged Cobbles	Baggeridge	30		100 x 100 x 65	A3	768	1152	100	Kingsbury
Baggeridge Blue Promenade Square Edged	Baggeridge	30		200 x 133 x 65	A3	288	1200	37	Kingsbury
Baggeridge Blue Tumbled Cobbles	Baggeridge	30		100 x 100 x 65	A2	768	1152	100	Smeed Dean
Baggeridge Red Promenade Square Edged	Baggeridge	30		200 x 133 x 65	A3	288	1200	37	Kingsbury
Baggeridge Telford Promenade Square Edged	Baggeridge	30		200 x 133 x 65	A3	288	1200	37	Kingsbury
Basalt DF	Dutch	24		200 x 65 x 80	A2	720	1536	75	Hull/Purfleet
Basalt WF	Dutch	24		200 x 50 x 80	A2	960	1507	100	Hull/Purfleet
Blue Dragfaced Chamfered	62mm	28		200 x 100 x 62	A3	396	1129	50	Kingsbury
Blue Dragfaced Square Edged	62mm	28		200 x 100 x 62	A3	396	1129	50	Kingsbury
Bochum Orange Multi	62mm	28		200 x 100 x 62	A3	560	1568	50	Kingsbury
Bochum Orange Multi - 52mm	Sycamore	36		200 x 100 x 52	A3	665	1449	50	Kingsbury
Bremen Brown - 52mm	Sycamore	36		200 x 100 x 52	A3	665	1530	50	Kingsbury
Bruno DF	Dutch	21		200 x 65 x 80	A2	720	1536	75	Hull/Purfleet
Bruno WF	Dutch	21		200 x 50 x 80	A2	960	1507	100	Hull/Purfleet
Bruno Waterstruck DF	Dutch	21		200 x 65 x 80	A2	660	1460	75	Hull/Purfleet
Bruno Waterstruck WF	Dutch	21		200 x 50 x 80	A2	752	1271	100	Hull/ Purfleet
Diamond Pattern Blue	Diamond	32		200 x 100 x 65	A3	400	1136	50	Kingsbury
Diamond Pattern Red	Diamond	32		200 x 100 x 65	A3	400	1136	50	Kingsbury
Dortmund Dark Multi	62mm	28		200 x 100 x 62	A3	560	1568	50	Kingsbury
Essen Red	62mm	28		200 x 100 x 62	A3	560	1568	50	Kingsbury
Gala Waterstruck DF	Dutch	23		200 x 65 x 80	A2	628	1476	75	Hull/Purfleet
Gala Waterstruck WF	Dutch	23		200 x 50 x 80	A2	816	1428	100	Hull/Purfleet
Hannover Buff Brindled	62mm	28		200 x 100 x 62	A3	560	1568	50	Kingsbury
Hannover Buff Brindled - 52mm	Sycamore	36		200 x 100 x 52	A3	665	1449	50	Kingsbury
Herne Dark Brindled	Dutch	22		210 x 50 x 70	A2	864	1296	90	Hull/Purfleet
Incana Waterstruck DF	Dutch	23		200 x 65 x 80	A2	628	1476	75	Hull/Purfleet
Incana Waterstruck WF	Dutch	23		200 x 50 x 80	A2	816	1428	100	Hull/Purfleet
KK80 Bruno	KK80	34		200 x 100 x 80	A3	500	1864	50	Hull/Purfleet
KK80 Nero	KK80	34		200 x 100 x 80	A3	500	1864	50	Hull/Purfleet



Dimensional deviation range	Mean traverse breaking load	Unpolished slip/skip resistance	Durability
All R1	All T4	All U3	All FP100

KEY  Pedestrian  Domestic car  General light van traffic  Heavy traffic

# INDEX

Product name	Range	Page number	Suitable for	Work size (mm)	Abrasion	Pack quantity	Typical pack weight	Quantity per m <sup>2</sup>	Location/ collection point
KK80 Omber	KK80	34		200 x 100 x 80	A3	500	1864	50	Hull/Purfleet
KK80 Padova	KK80	34		200 x 100 x 80	A3	500	1864	50	Hull/Purfleet
KK80 Paviona	KK80	34		200 x 100 x 80	A3	500	1864	50	Hull/Purfleet
Kelbra Multi – 52mm	Sycamore	36	 	200 x 100 x 52	A3	630	1450	50	Kingsbury
Koln Red Multi	Dutch	22		210 x 50 x 70	A2	864	1296	90	Hull/Purfleet
Lotis - 52mm	Sycamore	36	 	200 x 100 x 52	A2	600	1523	50	Kingsbury
Lotis UWF Tumbled	Alder	26		200 x 50 x 60	A2	1040	1366	100	Hull/Purfleet
Mastiek DF	Dutch	23		200 x 65 x 80	A2	720	1536	75	Hull/Purfleet
Mastiek WF	Dutch	23		200 x 50 x 80	A2	960	1507	100	Hull/Purfleet
Mastiek Waterstruck DF	Dutch	23		200 x 65 x 80	A2	720	1536	75	Hull/Purfleet
Mastiek Waterstruck WF	Dutch	23		200 x 50 x 80	A1	960	1507	100	Hull/Purfleet
Multi Brindled Dragfaced Chamfered	62mm	28		200 x 100 x 62	A3	396	1133	50	Kingsbury
Munster Red Brindled	62mm	28		200 x 100 x 62	A3	560	1568	50	Kingsbury
Munster Red Brindled - 52mm	Sycamore	36	 	200 x 100 x 52	A3	665	1530	50	Kingsbury
Nero DF	Dutch	24		200 x 65 x 80	A2	720	1536	75	Hull/Purfleet
Nero WF	Dutch	24		200 x 50 x 80	A2	960	1594	100	Hull/Purfleet
Nero Waterstruck DF	Dutch	24		200 x 65 x 80	A2	720	1536	75	Hull/Purfleet
Nero Waterstruck WF	Dutch	24		200 x 50 x 80	A2	960	1594	100	Hull/Purfleet
Novoton DF	Dutch	22		200 x 65 x 80	A2	824	1869	75	Hull/Purfleet
Novoton WF	Dutch	22		200 x 50 x 80	A2	1132	1868	100	Hull/Purfleet
Novoton Waterstruck DF	Dutch	22		200 x 65 x 80	A2	612	1438	75	Hull/Purfleet
Novoton Waterstruck WF	Dutch	22		200 x 50 x 80	A2	752	1316	100	Hull/Purfleet
Oliva Waterstruck DF	Dutch	23		200 x 64 x 80	A2	628	1476	75	Hull/Purfleet
Oliva Waterstruck WF	Dutch	23		200 x 48 x 80	A2	816	1428	75	Hull/Purfleet
Olsburg - 52mm	Sycamore	36	 	200 x 100 x 52	A3	468	1077	50	Kingsbury
Padova DF	Dutch	22		200 x 65 x 80	A2	720	1536	75	Hull/Purfleet
Padova WF	Dutch	22		200 x 50 x 80	A2	960	1507	100	Hull/Purfleet
Paviona DF	Dutch	21		200 x 65 x 80	A2	720	1536	75	Hull/Purfleet
Paviona WF	Dutch	21		200 x 50 x 80	A2	960	1507	100	Hull/Purfleet
Rosa Waterstruck DF	Dutch	22		200 x 65 x 80	A2	628	1476	75	Hull/Purfleet
Rosa Waterstruck WF	Dutch	22		200 x 50 x 80	A2	816	1428	100	Hull/Purfleet
Ruston UWF Tumbled	Alder	26		200 x 50 x 60	A1	1040	1250	100	Hull/Purfleet
Siena DF	Dutch	20		200 x 65 x 80	A2	720	1536	75	Hull/Purfleet
Siena WF	Dutch	20		200 x 50 x 80	A2	960	1582	100	Hull/Purfleet
Supraton UWF Tumbled	Alder	26		200 x 50 x 60	A1	1040	1312	100	Hull/Purfleet
Triton UWF Tumbled	Alder	26		200 x 50 x 60	A2	1040	1366	100	Hull/Purfleet
Varia Waterstruck DF	Dutch	20		200 x 65 x 80	A2	612	1438	75	Hull/Purfleet
Varia Waterstruck WF	Dutch	20		200 x 50 x 80	A2	752	1316	100	Hull/Purfleet

Dimensional deviation range	Mean traverse breaking load	Unpolished slip/skip resistance	Durability
All R1	All T4	All U3	All FP100

KEY  Pedestrian  Domestic car  General light van traffic  Heavy traffic



# Wienerberger

## Wall Solutions

-  **Terca**
-  **Porotherm**
-  **Corium**
-  **SVK**

## Roof Solutions

-  **Sandtoft**
-  **Koramic**
- KEYMER**

## Landscaping Solutions

-  **Penter**

Wienerberger Ltd  
Wienerberger House  
Brooks Drive  
Cheadle Royal Business Park  
Cheadle, Cheshire  
SK8 3SA

 0161 491 8200

 [wbukmarketing@wienerberger.com](mailto:wbukmarketing@wienerberger.com)

 [@wienerbergeruk](https://twitter.com/wienerbergeruk)

 [www.wienerberger.co.uk](http://www.wienerberger.co.uk)





