

MIRROR

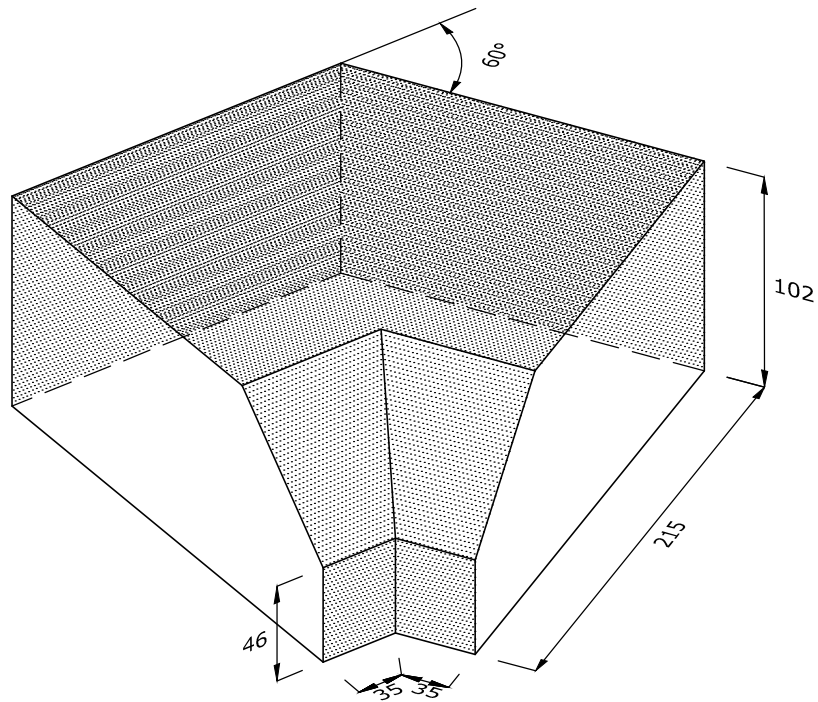

AN.11.5 SINGLE CANT INTERNAL ANGLE

Note: all specials may be perforated or froged unless otherwise specified.
Fired dimensions shown unless otherwise stated.

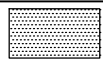

Indicates standard facing

This drawing is copyright.
All dimensions must be checked on site.
Any discrepancy to be reported to us and resolved prior to work commencing.

First issue date: 05.11.2018

Revision date:

Scale: NTS

Drawn by: AC