

LEFT HAND SHOWN

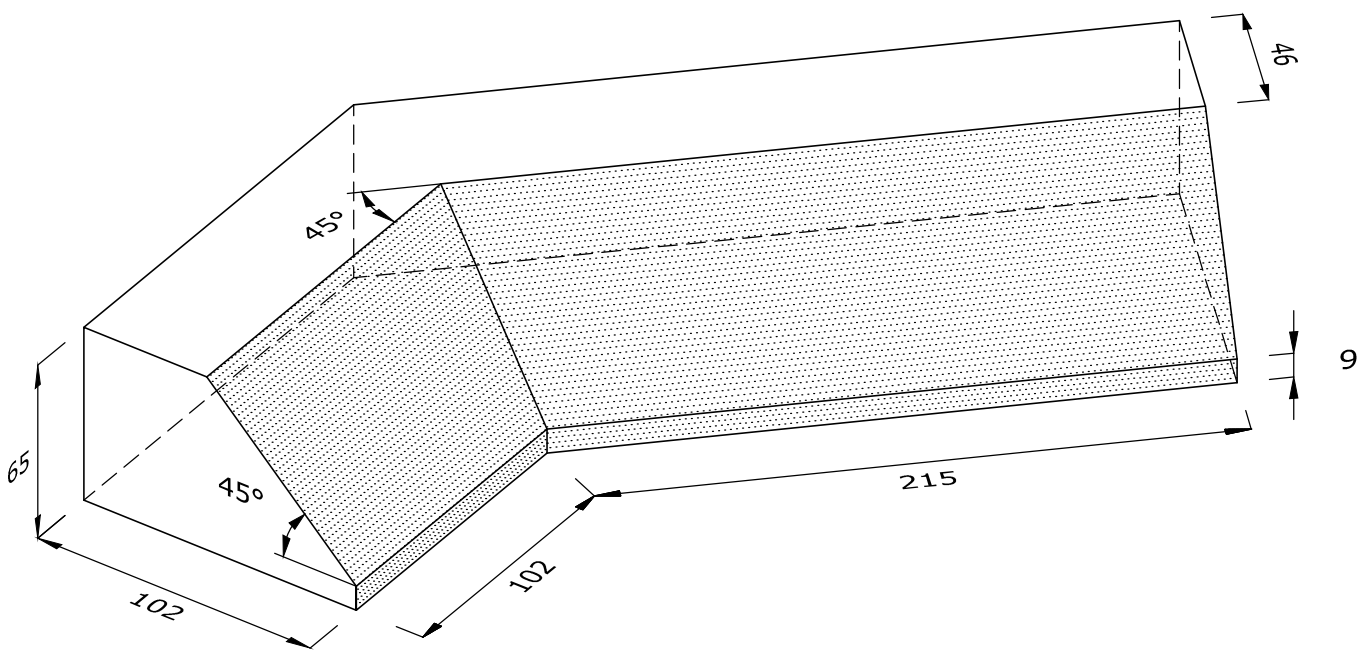

PL.6.15
PLINTH INTERNAL ANGLE

Note: all specials may be perforated or frogged unless otherwise specified.
Fired dimensions shown unless otherwise stated.



Indicates standard facing

This drawing is copyright.
All dimensions must be checked on site.
Any discrepancy to be reported to us and resolved prior to work commencing.

First issue date: 19.11.18

Revision date:

Scale: NTS

Drawn by: AC