

DUTCH PAVERS

Wienerberger has created its Dutch collection to achieve a new and unique look in larger areas of urban paving.

Wienerberger's mixed reds, cream, greys and waterstruck blends offer designers a wider choice and scope when designing new landscapes.



WORK SIZE	200 x 50 x 65mm
DIMENSIONAL DEVIATION (RANGE)	R1
MEAN TRANSVERSE BREAKING LOAD	T4
UNPOLISHED SLIP/SKID RESISTANCE	U3
ABRASION RESISTANCE	A2
DURABILITY	FP100
PACK QUANTITY	960
TYPICAL PACK WEIGHT (KG)	1392
QUANTITY PER m ²	100

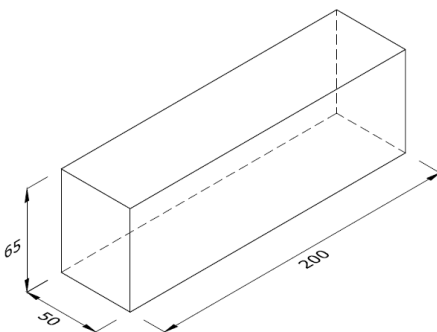

Wienerberger offers UK customers a choice of pavers in a wide range of colours, finishes and blends that can enhance any project. With a selection of complementary kerbs and paver accessories, Manufactured in accordance with BS EN 1344

 Case study available to view
www.wienerberger.co.uk/inspiration

T: 0845 303 2524

F: 0844 334 4100

✉ office@wienerberger.co.uk

🐦 @wienerbergeruk

🌐 www.wienerberger.co.uk